



ADVENTURES CHANGE QUALITY DOESN'T

Legendary engineering for
the world's unruly dreamers















PHOTO: SCOTT RINCKENBERGER

A LEGACY OF UNRIVALED PERFORMANCE



PHOTO: SCOTT RINCKENBERGER

2021 LINE PLAN | STOVES

 <p>REACTOR® STOVE SYSTEMS</p>	 <p>WINDBURNER® DUO STOVE SYSTEM</p>	 <p>XGK™ EX</p>	 <p>WINDBURNER® PERSONAL STOVE SYSTEM</p>	 <p>POCKETROCKET® 2</p>
 <p>WINDBURNER® STOVE SYSTEM COMBO</p>	 <p>WINDBURNER® GROUP STOVE SYSTEM</p>	 <p>WHISPERLITE™ INTERNATIONAL</p>	 <p>POCKETROCKET® DELUXE</p>	
		 <p>WHISPERLITE™ UNIVERSAL</p>	 <p>WHISPERLITE™</p>	
			 <p>WINDPRO™ II</p>	
			 <p>DRAGONFLY®</p>	

SIMMER

COOK

BOIL

CONVENTIONAL CANISTER STOVES

Delivering big performance in light and compact designs, MSR canister stoves are engineered to make wilderness cooking quick and easy. Each stove is designed to satisfy a unique demand—from ultralight, fast-boiling performance to precision simmering capabilities.

MUST HAVE



Outdoor GEAR LAB EDITOR'S CHOICE 2018

COOK

PocketRocket® Deluxe

Ultralight and fully featured for a consistently fast and excellent cooking experience.

- **Pressure Regulator:** Maintains stove's fast boil times even in cold weather and with low fuel.
- **Push-Start Ignition:** Fast, reliable piezo lighting; spark igniter is protected inside burner head for maximum durability.
- **Ultralight & Fast:** Just 83 g (2.9 oz); boils 1 liter of water in 3:20 minutes.
- **Broad Burner:** Improves wind resistance and combines with simmer control for excellent cooking versatility.

PocketRocket® Deluxe

SKU 10955
MADE IN KOREA

MUST HAVE



Outdoor GEAR LAB EDITOR'S CHOICE 2018

Section Hiker EDITOR'S CHOICE

BOIL

PocketRocket® 2

Our lightest and most compact, fast-boiling stove for serious gram-counters.

- **Ultralight:** At just 73 g (2.6 oz), this easy-to-use stove keeps pack weight to the absolute minimum.
- **Ultra-Compact:** Folding pot supports pack exceptionally small; stove with case fits inside MSR Titan™ Mug.
- **Fast:** Boils 1 liter of water in just 3.5 minutes.
- **Strong:** Robust pot supports accommodate a wide range of pot sizes.
- **Includes:** Ultralight hard-shell carry case.

PocketRocket® 2

SKU 09884
MADE IN KOREA

SIMMER

WindPro™ II

Excellent remote-canister stability for ultra-efficient cold weather performance.

- **Inverted Liquid-Feed:** Inverting canister allows stove to run on liquid fuel for increased cold-weather and low-fuel performance.
- **Remote Burner:** Added stability for use with large pots (up to 10" diameter).
- **Compatible:** Design allows the use of a windscreen; compatible with bake ovens.
- **Lightweight:** Weighs just 187 g (6.6 oz).

WindPro™ II

SKU 06636
MADE IN USA OF U.S. AND IMPORTED MATERIALS



STOVE KITS

Pairing high performance with pack-and-go convenience, our stove kits make the ultimate cook-and-eat solutions for backpacking duos and soloists moving fast.



PocketRocket® Deluxe Stove Kit

Our premium cook-and-eat kit takes ultralight adventures up a notch with deluxe features.

- **Premium Kit:** Pressure-regulated, push-start PocketRocket Deluxe stove + our ultralight Trail Mini Duo Cook Set.
- **Light & Compact:** Nested design slips easily into small packs and weighs just 371 g (13.1 oz).
- **Fast-Boiling:** Boils 1 liter in 3:20 minutes, maintaining fast boil times even in cold weather and with low fuel.
- **Integrated Piezo Igniter:** Fast, easy, reliable ignition.
- **Includes:** PocketRocket® Deluxe stove with stuff sack; 1.2 L hard-anodized aluminum pot with insulated grip; bowl;* strainer lid;* ultralight pot handle; kit stuff sack; room to nest 4- or 8-oz IsoPro™ fuel.

*BPA-free

PocketRocket® Deluxe Stove Kit

SKU 13099
MADE IN KOREA



PocketRocket® 2 Mini Stove Kit

Ultra-compact complete cook-and-eat solution for one, featuring our smallest and lightest stove.

- **Ultra-Compact:** Nested design slips easily into smaller day packs; makes a great back-up cook solution.
- **Ultralight:** Whole kit weighs a mere 278 g (9.8 oz), keeping pack weight to an absolute minimum.
- **Fast-Boiling:** PocketRocket 2 stove boils 1 liter in 3.5 minutes.
- **Versatile:** Pot's insulated grip makes it safe to hold when hot.
- **Includes:** PocketRocket 2 stove, .75 L hard-anodized aluminum pot, bowl,* clear lid* with straining port, ultralight pot lifter.

*BPA free

PocketRocket® 2 Mini Stove Kit

SKU 10379
MADE IN KOREA



PocketRocket® Stove Kit

Complete cook-and-eat kit for two, featuring the original, iconic PocketRocket stove.

- **Fast-Boiling:** Original PocketRocket stove boils 1 liter in 3.5 minutes.
- **Lightweight:** Whole kit weighs only 732 g (25.8 oz), making it great for backpacking.
- **Compact:** Nested design packs easily and discreetly.
- **Includes:** PocketRocket stove, 2.0 L hard-anodized aluminum pot, (2) DeepDish™ Bowls,* (2) 12.5 oz Double-Wall Insulated Mugs,* clear strainer lid,* (2) folding sporks.*

*BPA-free

PocketRocket® Stove Kit

SKU 09567
MADE IN THAILAND

WINDBURNER® STOVE SYSTEMS

The WindBurner stove's windproof and pressure-regulated design allows it to boil water fast in weather that shuts other stoves down, while unique stove system features add cook-and-eat convenience.

MUST
HAVE



MUST
HAVE



BOIL

WindBurner® Personal Stove System

Fast, fuel-efficient personal stove system for soloists and minimalist trips.

- Optimized for backcountry soloists or pairs creating one-pot meals and quick brew-ups
- Compact, all-in-one, fast-boil system with personal cook-and-eat features
- 1.0 L Personal Pot with handheld design locks onto stove and canister

WindBurner® Personal Stove System	
SIZE	1.0 L
COLOR	
SKU	09219 06464
MADE IN	USA OF U.S. AND IMPORTED MATERIALS

BOIL

WindBurner® Duo Stove System

WindBurner Stove System performance sized for two backpackers.

- Ideal for trips with 2-3 people, fast-boil meals and making coffee/tea
- Compact, all-in-one, fast-boil system with personal cook-and-eat features
- Anti-topple remote canister design and self-centering pot

WindBurner® Duo Stove System	
SIZE	1.8 L
COLOR	
SKU	10366
MADE IN	USA OF U.S. AND IMPORTED MATERIALS

COOK

UPDATED

WindBurner® Group Stove System

Our larger capacity 2.5 L system is perfect for small groups and optimized for simmering.

- Fusion® nonstick ceramic-coated 2.5 L Sauce Pot serves 2-4 people
- Features enclosed, heat-capturing ring for cooking versatility
- Nests stove and 8 oz fuel canister for rattle-free packing efficiency
- Anti-topple remote canister design and self-centering pot

WindBurner® Group Stove System	
SIZE	2.5 L
SKU	13491
MADE IN	USA OF U.S. AND IMPORTED MATERIALS

COOK

UPDATED

WindBurner® Stove System Combo

The ultimate tools for group and gourmet cooking.

- Fusion® nonstick ceramic-coated 2.5 L Sauce Pot and 8" Skillet for multipurpose cooking
- Features enclosed, heat-capturing ring
- Pot nests stove and 8 oz fuel canister
- Anti-topple remote canister design and self-centering pots

WindBurner® Stove System Combo	
SIZE	2.5 L and 8 in (20 cm) Skillet
SKU	13492
MADE IN	USA OF U.S. AND IMPORTED MATERIALS

Fusion® is a registered trademark of Whitford.

WHY WINDBURNER™?

**BOILS UP TO 4X FASTER
THAN THE COMPETITORS' STOVES
IN WINDY & COLDER CONDITIONS
(12 MPH / 40°F)**

PRESSURE REGULATOR

Ensures constant performance even as canister pressure drops in colder temps or with low fuel.

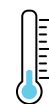

WINDPROOF

Radiant burner and 100% primary air combustion allow flame to be shielded from the wind, significantly reducing heat loss for faster boil times using less fuel.

COOKWARE FOR EVERY KIND OF TRIP



FAST WATER BOILERS

Powerful heat exchanger maximizes heat transfer to the pot for rapid boil times.



NONSTICK COOKING POTS

A heat-capturing ring blocks the wind while dispersing heat evenly for cooking versatility.



UPDATED

WindBurner® Ceramic Skillet

Premium nonstick performance for stir-fry, pancakes or gourmet cooking.

- Hard-anodized aluminum skillet with Fusion® ceramic nonstick surface
- Talon Pot Handle
- Nests outside of WindBurner Stock Pot

WindBurner® Ceramic Skillet	
SIZE	8 in (20 cm)
SKU	13494
MADE IN	THAILAND



UPDATED

WindBurner® Sauce Pot

Ceramic-coated 2.5 L pot for our WindBurner stove systems.

- 2.5 L Sauce Pot serves 2-4 people
- Durable Fusion® ceramic coating makes meal clean-up fast and easy
- Features enclosed, heat-capturing ring

WindBurner® Sauce Pot	
SIZE	2.5 L
SKU	13493
MADE IN	THAILAND



WindBurner® Stock Pot

Fast-boiling 4.5 L pot for our WindBurner stove systems.

- Our largest capacity pot for groups & large volume cooking
- Features high-performance heat exchanger for our fastest boil times
- Self-centering pot fits WindBurner stoves' deep lip for increased stability

WindBurner® Stock Pot	
SIZE	4.5 L
SKU	10370
MADE IN	THAILAND

WindBurner® Personal Accessory Pot

1.0 L pot for our WindBurner stove systems.

- Extra pot lets you and a companion share one burner, reducing pack weight
- Compatible with all WindBurner stove systems
- Includes 1.0 L Pot with fast-boil heat exchanger, canister stand and bowl

WindBurner® Personal Accessory Pot	
SIZE	1.0 L
COLOR	
SKU	09221
MADE IN	THAILAND

WindBurner® Duo Accessory Pot

1.8 L pot for our WindBurner stove systems.

- Added capacity for an extra companion
- Compatible with all WindBurner stove systems
- Includes: 1.8 L Pot with fast-boil heat exchanger, canister stand and bowl

WindBurner® Duo Accessory Pot	
SIZE	1.8 L
COLOR	
SKU	05801
MADE IN	THAILAND

REACTOR® STOVE SYSTEMS

The fastest backcountry water-boiling and snow-melting powerhouses on the planet, Reactor Stove Systems deliver in challenging alpine conditions, where wind and cold can wreak havoc on a stove's reliability.



BOIL

Reactor® 1.0 L Stove System

The world's fastest, most fuel-efficient all-condition stove system for one.

- Ideal for backcountry soloists or pairs
- Reactor Stove System performance in the lightest & smallest possible configuration

Reactor® 1.0 L Stove System	
SKU	06898
MADE IN	USA OF US AND IMPORTED MATERIALS



BOIL

Reactor® 1.7 L Stove System

The world's fastest, most fuel-efficient all-condition stove system for 2-3 people.

- Ideal for trips with 2-3 people
- Big enough for melting snow, small enough to go on any journey

Reactor® 1.7 L Stove System	
SKU	11205
MADE IN	USA OF US AND IMPORTED MATERIALS



BOIL

Reactor® 2.5 L Stove System

Our largest-capacity Reactor Stove System for serving small groups.

- Great for groups of 2-4 people
- Wider pot makes it a snow-melting, expedition powerhouse

Reactor® 2.5 L Stove System	
SKU	06902
MADE IN	USA OF US AND IMPORTED MATERIALS



WHY REACTOR®?

UNRIVALED IN REAL BACKCOUNTRY CONDITIONS

WINDPROOF

100% primary air combustion means the stove draws the oxygen it needs through ports near its burner, allowing the flame to be completely enclosed and protected from the wind.

PRESSURE REGULATED

High-quality regulator ensures consistent performance at altitude, in colder weather or with a nearly empty canister.

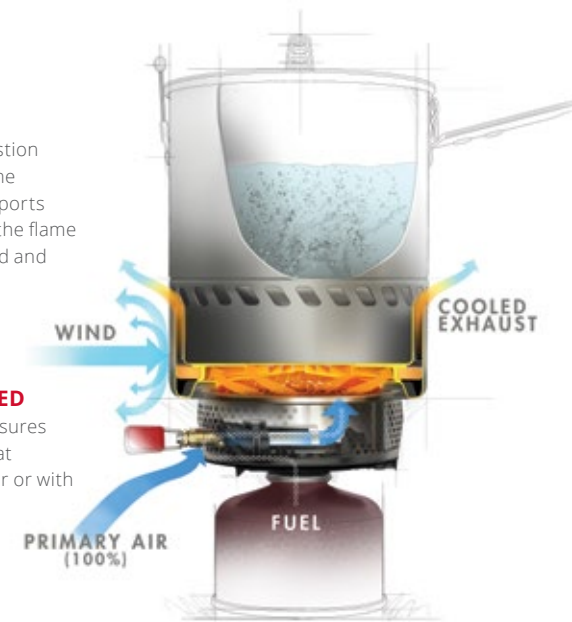

SUPEREFFICIENT COOKWARE

Heat exchangers make the most efficient use of the stove's output while providing wind protection, resulting in extremely fast boil times.

RADIANT BURNER POWER

Provides greater performance and efficiency than conventional burners—and significantly more wind resistance.

REACTOR 1.7 L STOVE SYSTEM'S UNRIVALED BOIL TIMES:

WIND	BOIL TIME (MIN/1 L)		FUEL USED (g/1 L)
0 MPH	REACTOR	3:00 min	10 g
	COMPETITION*	4:30 min	09 g
8 MPH	REACTOR	3:30 min	12 g
	COMPETITION*	8:15 min	19 g
12 MPH	REACTOR	3:45 min	12 g
	COMPETITION*	20:00 min	44 g

*Leading competitor's pressure regulated stove system.



Reactor® 1.0 L Pot

Our smallest standalone Reactor pot.

- Perfect for solo or partner missions
- Use it to slim down your system when space and weight are at a premium

Reactor® 1.0 L Pot	
SKU	06900
MADE IN	THAILAND



Reactor® 1.7 L Pot

A standalone Reactor pot that serves 2-3 people.

- Ideal for 2-3 people
- Sized perfectly for alpine pursuits and snow-melting duties

Reactor® 1.7 L Pot	
SKU	06901
MADE IN	THAILAND



Reactor® 2.5 L Pot

Our largest-volume Reactor pot.

- Great for groups of 2-4 people
- Wider pot meets bigger snow-melting and water-boiling demands

Reactor® 2.5 L Pot	
SKU	02166
MADE IN	THAILAND

LIQUID FUEL STOVES

MSR liquid fuel stoves are the epitome of reliability. These time-tested machines remain the mainstay of backpackers, mountain guides and outdoor chefs for their four-season performance, large-pot stability, multi-fuel capabilities and dependable engineering.



SIMMER

Dragonfly®

Unbeatable reliability and versatility for a wide range of meals and group sizes.

- **Unrivaled Flame Control:** Dual-valve technology allows precision boil-to-simmer control.
- **Extra Wide Pot Supports:** Easily holds up to 10" diameter MSR pots or fry pans.
- **Multi-Fuel:** Burns white gas, kerosene, unleaded auto fuel, diesel and jet fuel.
- **Efficient:** Suspended burner cup produces a strong burn while reducing heat lost to the ground.
- **Field Maintainable:** Shaker Jet™ technology allows easy cleaning and field maintenance.

Dragonfly®

11774

USA OF U.S. AND IMPORTED MATERIALS

BOIL

XGK™ EX

The most reliable multi-fuel powerhouse ever built.

- **Multi-Fuel:** Burns white gas, kerosene, diesel, jet fuel, aviation gas and unleaded auto gas.
- **Unmatched Reliability:** Shaker Jet™ technology and unique fuel delivery ensure a clean burn regardless of fuel.
- **Rugged Build:** Engineered for exceptional stability and lasting durability.
- **Fast:** Boils water in as little as 2.8 minutes.

XGK™ EX

SKU 11043

MADE IN USA



COOK

WhisperLite™ Universal

World's first optimal performance hybrid-fuel stove—the most effective one ever made.

- **Hybrid Fuel:** Burns canister fuel, white gas, kerosene and unleaded gasoline.
- **Canister Liquid Feed:** Inverting canister allows stove to run on liquid fuel for increased cold-weather and low-fuel performance.
- **Groundbreaking Performance:** AirControl™ technology maximizes the fuel and air mixture with each fuel type.
- **Light and Sturdy:** Lightweight stainless steel legs offer excellent stability.
- **Easy Maintenance:** Extremely easy to swap jets and perform periodic maintenance.

WhisperLite™ Universal

SKU 06630

MADE IN USA OF U.S. AND IMPORTED MATERIALS

COOK

WhisperLite™ International

Legendary, multi-liquid-fuel performance made even better.

- **Multi-Fuel:** Burns white gas, kerosene and unleaded gasoline.
- **Light & Sturdy:** Lightweight stainless steel legs offer excellent stability.
- **Proven:** Based on a design that's been proven worldwide for decades.
- **Easy Maintenance:** Extremely easy to swap jets and perform periodic maintenance.

WhisperLite™ International

06633

USA OF U.S. AND IMPORTED MATERIALS

COOK

WhisperLite™

Our best-selling liquid-fuel stove ever.

- **Proven:** Trusted leader for over 30 years.
- **Reliable:** Simple, durable design.
- **Self-Cleaning:** Shaker Jet™ cleans fuel jet with a simple shake.
- **Compact:** Fits in a 1.5-liter MSR pot.

WhisperLite™

11782

USA OF U.S. AND IMPORTED MATERIALS

FUEL

MSR's fuels are formulated to the absolute highest standards. Free of additives that cause clogs, their performance-boosting blends burn cleaner and deliver better cold weather performance than any other fuels on the market.



MSR® Fuel Bottles

Designed to work with all MSR liquid-fuel stoves.

- **Airtight:** Allows fuel to be stored longer by preventing air to enter and degrade fuel.
- **Rugged:** Made from a single piece of impact-extruded aluminum to prevent leaks.
- **Child-Proof:** Push-down-and-turn child resistant cap.

	MSR® Fuel Bottles		
SIZE	325 ml (11 oz)	590 ml (20 oz)	887 ml (30 oz)
SKU	11830	11831	11832
MADE IN	CHINA		



IsoPro™

Our premium, clean-burning, performance-boosting fuel blend.

- **Three Sizes:** 4, 8 and 16 oz canisters meet the demands of any stove or trip; 4 oz canister fits inside the 1.0 L Reactor® and WindBurner® Stove Systems.
- **Superior Performance:** 80/20 blend of isobutane and propane delivers superior cold-weather performance and more consistent output over the life of the canister.
- **Clean-Burning:** Zero-maintenance combustion.
- **Fuel Gauge:** Built-in float gauge determines how much fuel is left (4 oz and 8 oz canisters).

	IsoPro™		
SIZE	110 g (4 oz)	226 g (8 oz)	450 g (16 oz)
SKU	06927	322100	04589
MADE IN	KOREA		



SuperFuel™

The highest-performance, clean-burning white gas available.

- **Superior Performance:** Designed to improve stove performance, with fewer cleanings and less maintenance.
- **Clean-Burning:** Tested to be 100% pure.
- **Reduced Clogging:** No dyes or additives to solidify and cause clogs.

	SuperFuel™
SIZE	.95 L (1 QT)
SKU	322020
MADE IN	USA

REDUCING WASTE IN LANDFILLS

LIQUID FUEL: THE SUSTAINABLE CHOICE

Liquid fuel stoves remain the clear choice for eco-conscious adventurers. The key reason? Liquid fuel bottles are reusable, meaning you can refill them time and again before each trip—and you won't end up with bins of half-used canisters.



MSR's FUEL CANISTER RECYCLING PROGRAM

Each year, MSR's Fuel Canister Recycling Program keeps hundreds of canisters out of landfills. In fact, our repair shop is the City of Seattle's listed site for recycling any brand of backpacking fuel canister—a service we provide consumers for free!



STOVE ACCESSORIES



WindBurner® Coffee Press Kits

- Turn your WindBurner Stove System into a rapid, windproof brewing machine
- Fits WindBurner Personal and Duo Pots

WindBurner® Coffee Press Kits		
SIZE	1.0 L	1.8 L
SKU	09223	09312
MADE IN	TAIWAN	



WindBurner® Hanging Kit

- Ideal for climbing, mountaineering, ski touring and snowshoeing
- Lightweight, durable cable system and sliding tensioner
- Fits WindBurner Personal Stove System

WindBurner® Hanging Kit	
SIZE	1.0 L
SKU	09222
MADE IN	USA OF U.S. AND IMPORTED MATERIALS



Universal Canister Stand

- Super-stable wide base
- Adjustable universal fit system ensures worldwide canister compatibility

Universal Canister Stand	
SKU	05346
MADE IN	TAIWAN

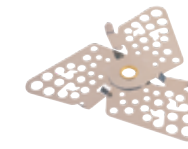

Trillium™ Stove Base

- Lightweight portable platform for resting any MSR stove on for added stability
- MSR Dragonfly® stove locks securely with the Trillium Stove Base

Trillium™ Stove Base	
SKU	11810
MADE IN	USA



Solid Heat Reflector with Windscreen

- Reflector speeds boil times, reduces fuel use
- Windscreen improves stove performance
- For use with MSR liquid-fuel stoves or WindPro™ canister stove

Solid Heat Reflector with Windscreen	
SKU	11812
MADE IN	USA



Reactor® Coffee Press Kits

- Etched, easy-to-clean stainless steel strainer disc for a grind-free cup of coffee
- Disassembles and lays flat for low-profile packing
- Fits Reactor 1.0 L and 1.7 L Pots

Reactor® Coffee Press Kits		
SIZE	1.0 L	1.7 L
SKU	06905	06906
MADE IN	TAIWAN	



Reactor® Hanging Kit

- Ideal for climbing, mountaineering, ski touring and snowshoeing
- Narrow base and sliding tensioner ensure maximum stability
- Fits all Reactor stove systems

Reactor® Hanging Kit	
ONE SIZE FITS ALL	
SKU	06926
MADE IN	USA OF US AND IMPORTED MATERIALS



MSR® Fuel Pumps

- Lightest, most reliable pumps on the market
- Fiberglass-reinforced polymer design doubles pump strength
- Innovative valve for superior flame control; easy-to-maintain seal
- Works with all MSR liquid-fuel stoves

	Standard	Dragonfly®
SKU	11794	11796
MADE IN	USA	



Arctic Fuel Pump

- Designed specifically for extreme arctic temperatures
- Seals and pump cup remain flexible to prevent leaks
- Do not use in temperatures above freezing

Arctic Fuel Pump	
SKU	09962
MADE IN	USA OF U.S. AND IMPORTED MATERIALS



Expedition Fuel Bottle Cap

- Compatible with all MSR liquid fuel bottles

Expedition Fuel Bottle Cap	
SKU	29129
MADE IN	CANADA



Child Resistant Fuel Bottle Cap

- "Push-down-and-turn" cap
- Compatible with MSR liquid fuel bottles made after 1981
- Meets U.S. CFR1700 and Health Canada requirements

Child Resistant Fuel Bottle Cap	
SKU	29133
MADE IN	CHINA



Piezo Igniter

- Protective metal tube houses element, collects fuel vapor for reliable ignition
- Works with most canister stoves (except Reactor & WindBurner systems)

Piezo Igniter	
SKU	06930
MADE IN	KOREA



Strike Igniter

- Ultralight & weather-resistant
- Moisture and pressure don't affect performance
- Produces 5,500°F sparks to light stoves quickly
- 3,000 to 12,000 strikes—far more than average lighters

Strike Igniter	
SKU	03167
MADE IN	TAIWAN



Annual Maintenance Kit

- Services every MSR stove (except stove systems) and fuel pump
- **Includes:** O-rings, jet-and-cable tool, and lubricant for annual preventive maintenance

Annual Maintenance Kit	
SKU	11814
MADE IN	USA OF U.S. AND IMPORTED MATERIALS



Expedition Service Kits

- Maintenance and repair kits for every MSR liquid-fuel stove and pump
- **Includes:** All components needed to replace worn or damaged stove and pump parts

XGK™ EX	Dragonfly®	WL / WLI / WLU
SKU	11816	11818
SKU		06838
MADE IN	USA OF U.S. AND IMPORTED MATERIALS	

**MSR® STOVES SPECIFICATIONS**

STOVE SYSTEMS	COLOR / SKU	FUEL	BOIL TIME (1L WATER)	WATER BOILED		BURN TIME (PER 8 oz CANISTER)	WEIGHT	
				PER 8 oz FUEL CANISTER	PER OUNCE OF FUEL		MINIMUM	PACKAGED
WindBurner® Personal System	09219	MSR® IsoPro™	4.5 min	18 L	2.3 L	~95 min	15.3 oz (433 g)	16.4 oz (465 g)
	06464							
WindBurner® Duo System	10366	MSR® IsoPro™	4.5 min	18 L	2.3 L	~95 min	21.1 oz (597 g)	21.3 oz (605 g)
WindBurner® Group System	13491	MSR® IsoPro™	6.2 min	14 L	1.8 L	~95 min	20.8 oz (591 g)	21.1 oz (599 g)
WindBurner® Combo System	13492	MSR® IsoPro™	6.2 min	14 L	1.8 L	~95 min	29 oz (823 g)	29.3 oz (831 g)
Reactor® 1.0 L	06898	MSR® IsoPro™	3.5 min	20 L	2.5 L	~80 min	14.7 oz (417 g)	434 g (15.3 oz)
Reactor® 1.7 L	11205	MSR® IsoPro™	3 min	22 L	2.8 L	~80 min	17.5 oz (496 g)	18.1 oz (513 g)
Reactor® 2.5 L	06902	MSR® IsoPro™	3 min	22 L	2.8 L	~80 min	20.7 oz (588 g)	21.4 oz (607 g)

POTS	COLOR / SKU	BOIL TIME (1 L WATER)	COMPONENTS	WEIGHT	PACKED SIZE
WindBurner® Personal Pot	09221	4.5 min	1.0 L Hard-anodized aluminum pot w/ strainer lid, insulating cozy, 16 oz cup, PackTowl® insert	8.7 oz (247 g)	10.8 x 17.4 cm (4.25 x 6.9 in)
WindBurner® Duo Pot	05801	4.5 min	1.8 L Hard-anodized aluminum pot w/ strainer lid, insulating cozy, 28 oz cup, PackTowl® insert	13.2 oz (373 g)	13.3 x 20 cm (5.25 x 7.9 in)
WindBurner® Sauce Pot	13493	6.2 min	2.5 L Fusion® ceramic coated aluminum pot w/ strainer lid and Talon Pot Handle	12.2 oz (345 g)	19.7 x 13.3 cm (7.75 x 5.25 in)
WindBurner® Stock Pot	10370	3.8 min	4.5 L Hard-anodized aluminum pot w/ strainer lid	20.7 oz (568 g)	27.3 x 17.8 cm (10.75 x 7 in)
WindBurner® Ceramic Skillet	13494		20 cm Fusion® ceramic coated aluminum skillet	8.5 oz (240 g)	20.3 x 7 cm (8 x 2.75 in)
Reactor® 1.0 L Pot	06900	3.5 min	1.0 L Hard-anodized aluminum pot w/ strainer lid, PackTowl® insert	8.5 oz (240 g)	12.5 x 16.6 cm (4.9 x 6.5 in)
Reactor® 1.7 L Pot	06901	3 min	1.7 L Hard-anodized aluminum pot w/ strainer lid, PackTowl® insert	10.6 oz (299 g)	30.5 x 15.9 cm (12 x 6.25 in)
Reactor® 2.5 L Pot	02166	3 min	2.5 L Hard-anodized aluminum pot w/ strainer lid, Talon™ Pot Handle, PackTowl® stove cozy	13.8 oz (391 g)	22.2 x 13.3 cm (8.75 x 5.25 in)

Fusion® is a registered trademark of Whitford.

**MSR® STOVES SPECIFICATIONS**

CONVENTIONAL CANISTER STOVES	SKU	FUEL	BOIL TIME (1 L WATER)	WATER BOILED		BURN TIME (PER 8 oz CANISTER)	WEIGHT	
				PER 8 oz FUEL CANISTER	PER OUNCE OF FUEL		MINIMUM	PACKAGED
PocketRocket® Deluxe	10955	MSR® IsoPro™	3.3 min	17 L	2.2 L	~60 min	2.9 oz (83 g)	3.4 oz (97 g)
PocketRocket® 2	09884	MSR® IsoPro™	3.5 min	16 L	2 L	~60 min	2.6 oz (73 g)	3.7 oz (105 g)
WindPro™ II	06636	MSR® IsoPro™	3.6 min	15 L	1.8 L	~70 min	6.6 oz (187 g)	10.3 oz (292 g)

STOVE KITS	SKU	FUEL	BOIL TIME (1L WATER)	WATER BOILED		BURN TIME (PER 8 oz CANISTER)	WEIGHT	
				PER 8 OUNCE OF FUEL	PER OUNCE OF FUEL		MINIMUM	PACKAGED
PocketRocket® Deluxe Stove Kit	13099	MSR® IsoPro™	3.3 min	17 L	2.2 L	~60 min	13.1 oz (371 g)	
PocketRocket® 2 Mini Stove Kit	10379	MSR® IsoPro™	3.5 min	16 L	2 L	~60 min	9.8 oz (278 g)	
PocketRocket® Stove Kit	09567	MSR® IsoPro™	3.5 min	16 L	2 L	~60 min	25.8 oz (732 g)	

LIQUID FUEL STOVES	SKU	FUEL	BOIL TIME (1 L WATER)	WATER BOILED			BURN TIME (PER 20 OZ FUEL BOTTLE/ 8 OZ CANISTER)	WEIGHT	
				PER 20 OZ FUEL BOTTLE	PER OUNCE OF FUEL	PER 100ML OF FUEL		MINIMUM	PACKAGED
XGK™ EX	11043	White Gas	3.5 min	30 L	1.5 L	4.9 L	~109 min	13.5 oz (384 g)	17.2 oz (489 g)
		Kerosene	2.8 min	34 L	1.7 L	5.7 L			
		Diesel	4.5 min	38 L	1.9 L	6.3 L			
Dragonfly®	11774	White Gas	3.5 min	32 L	1.6 L	5.3 L	~126 min	14.1 oz (401 g)	17.8 oz (506 g)
		Kerosene	3.9 min	34 L	1.7 L	5.7 L			
		Diesel	3.5 min	34 L	1.7 L	5.7 L			
WhisperLite™ Universal	06630	White Gas	3.5 min	25 L	1.3 L	4.4 L	~110 min	11.2 oz (318 g)	14.9 oz (423 g)
		Kerosene	4.4 min	34 L	1.6 L	5.3 L			
		MSR® IsoPro™	3.75 min	NA	1.8 L	NA			
WhisperLite™ International	06633	White Gas	3.5 min	25 L	1.3 L	4.4 L	~110 min	11.2 oz (318 g)	14.9 oz (423 g)
		Kerosene	4.4 min	34 L	1.6 L	5.3 L			
WhisperLite™	11782	White Gas	3.9 min	30 L	1.5 L	5.1 L	~155 min	11.5 oz (326 g)	15.2 oz (431 g)

WEIGHTS: Minimum weight of liquid fuel stove includes the stove and fuel pump only. Minimum weight of canister stove includes stove only.**NOTE:** These charts are for comparison purposes only. Testing was conducted in a room-temperature laboratory at sea level with 21° C / 70° F water. Field conditions vary in every conceivable way, which will result in different burn and boil times.

ELEVATING THE COOKING EXPERIENCE



PHOTO: SCOTT RINCKENBERGER

2021 LINE PLAN | COOKWARE

ALPINE™ 2 POT SET ALPINE™ 4 POT SET ALPINE™ FRY PAN ALPINE™ STOWAWAY™ POTS ALPINE™ PLATE ALPINE™ NESTING BOWL	TRAIL LITE™ 2L POT TRAIL LITE™ 1.3L POT QUICK SKILLET PIKA™ 1L TEAPOT	CERAMIC 2-POT SET CERAMIC SOLO POT CERAMIC SKILLET CERAMIC 2.5L POT	TITAN™ 2-POT SET BIG TITAN™ KETTLE TITAN™ KETTLE TITAN™ CUP	FLEX™ 4 COOK SET FLEX™ 3 COOK SET QUICK 2 COOK SET ALPINIST™ 2 COOK SET TRAIL LITE™ SOLO COOK SET TRAIL LITE™ DUO COOK SET TRAIL MINI™ SOLO COOK SET TRAIL MINI™ DUO COOK SET
<p>\$\$\$</p>	<p>\$\$\$</p>	<p>\$\$</p>	<p>\$\$</p>	<p>\$</p>
STAINLESS		HARD ANODIZED		CERAMIC NONSTICK
		TITANIUM		SETS

CERAMIC NONSTICK

Safe at high heat and safe for your health, our Fusion® ceramic coating is the absolute best choice for nonstick performance at camp. More durable than other types of coatings, this premium ceramic is the toughest we've ever found.



Ceramic Solo Pot

Lightweight nonstick aluminum pot with durable Fusion® ceramic for solo and simple backcountry meals.

- 1.3 L hard-anodized aluminum pot with ceramic interior and strainer lid
- Talon Pot Handle

Ceramic Solo Pot	
SKU	13230
MADE IN	THAILAND



Ceramic 2.5 L Pot

Extra capacity for 2-4 people and larger dinner duties. Great for soups, sauces & gourmet fare.

- 2.5 L hard-anodized aluminum pot with Fusion® ceramic nonstick surface and strainer lid
- Talon Pot Handle
- Nests up to three Insulated Mugs and two DeepDish™ plates

Ceramic 2.5 L Pot	
SKU	13231
MADE IN	THAILAND

MUST HAVE



Ceramic 2-Pot Set

Compact nonstick set with premium Fusion® ceramic, perfect for making complex backcountry meals.

INCLUDES:

- 1.5 L hard-anodized aluminum pot with ceramic nonstick surface and strainer lid
- 2.5 L hard-anodized aluminum pot with ceramic nonstick surface
- Talon™ Pot Handle
- Room for nesting mugs and plates

Ceramic 2-Pot Set	
SKU	13232
MADE IN	THAILAND



Ceramic Skillet

Safe, durable Fusion® ceramic nonstick performance for stir-fry, pancakes, eggs and more.

- Hard-anodized aluminum skillet with ceramic nonstick surface
- Talon Pot Handle
- Nests inside a Flex™ 4 Cook Set and outside a Flex 3 Cook Set

Ceramic Flex™ Skillet	
SKU	13233
MADE IN	THAILAND

HARD-ANODIZED ALUMINUM

Offering the lightness of aluminum with the strength of a hard-anodized finish, these reliable, workhorse pots are perfect for preparing simple one-pot meals—and building a cook kit that will last.



Trail Lite™ 1.3 L Pot

Light, rugged, reliable pot for simple meals favored by soloists on the trail.

- 1.3 L hard-anodized aluminum pot with strainer lid
- Folding, locking handle

TrailLite™ 1.3 L Pot	
SKU	13234
MADE IN	THAILAND

MUST HAVE



Trail Lite™ 2 L Pot

Light, durable, compact pot for 2, designed to save room in packs.

- 2.0 L hard-anodized aluminum pot with strainer lid
- Folding, locking handle

TrailLite™ 2 L Pot	
SKU	13235
MADE IN	THAILAND



Pika™ 1 L Teapot

Ultralight, compact hard-anodized aluminum teapot with wide opening for easy cleaning.

- Featherweight—just 147 g (5.2 oz)
- Secure lid
- Strong, precise pour
- Stows PocketRocket® 2 with case or PocketRocket Deluxe stove

Pika™ 1 L Teapot	
SKU	10942
MADE IN	CHINA

TRADITIONAL NONSTICK

MUST HAVE



Quick Skillet

Compact skillet that adds cooking versatility to minimalist camp kitchens.

- 7" hard-anodized aluminum nonstick skillet
- Talon Pot Handle
- Nests with Quick 2 Cook Set, Ceramic 2.5 L Pot, and Ceramic 2-Pot Set

Quick Skillet	
SKU	05330
MADE IN	THAILAND

COOK SETS

The ultimate in packing and cooking convenience, these all-in-one solutions feature perfectly engineered and nested cookware pairings to suit a range of culinary demands. Everyone from soloists to groups can find a cook set to meet their needs.



Trail Lite™ Duo Cook Set



Lightweight & compact cook set for two that keeps the menu options open.

- INCLUDES:**
- 2.0 L hard-anodized aluminum pot with strainer lid
 - 2 polypropylene Insulated Mugs
 - 2 polypropylene DeepDish™ Bowls
 - Folding, locking handle



Trail Lite™ Solo Cook Set



Lightweight & compact cookware engineered for solo travelers.

- INCLUDES:**
- 1.3 L hard-anodized aluminum pot with strainer lid
 - 1 polypropylene Insulated Mug
 - 1 polypropylene DeepDish™ Bowl
 - Folding, locking handle



Flex™ 4 Cook Set



Comprehensive set for four or more on frontcountry camping or commercial backcountry trips.

- INCLUDES:**
- 3.2 L nonstick hard-anodized aluminum pot
 - 5.3 L dual handle hard-anodized aluminum pot
 - 2 strainer lids
 - Talon Pot Handle
 - 4 polypropylene DeepDish™ Plates
 - 4 - 12.5 oz polypropylene Insulated Mugs



Flex™ 3 Cook Set



Versatile, high-capacity cook & eat set for groups of three or more.

- INCLUDES:**
- 2.3 L nonstick hard-anodized aluminum pot
 - 3.3 L hard-anodized aluminum pot with strainer lid
 - Talon Pot Handle
 - 3 polypropylene DeepDish Plates
 - 3 - 12.5 oz polypropylene Insulated Mugs

Trail Lite™ Duo Cook Set

SKU 06897
MADE IN THAILAND

Trail Lite™ Solo Cook Set

SKU 10373
MADE IN THAILAND

Flex™ 4 Cook Set

SKU 05996
MADE IN THAILAND

Flex™ 3 Cook Set

SKU 05995
MADE IN THAILAND



Trail Mini™ Duo Cook Set



The ultimate space-maximizing, minimalist cook set for two backpackers.

- INCLUDES:**
- 1.2 L hard-anodized aluminum pot with insulated grip
 - 28 oz bowl
 - Lid with straining ports
 - Ultralight pot lifter
 - Room to nest PocketRocket® 2 stove and 8 oz fuel canister



Trail Mini™ Solo Cook Set



Our smallest and lightest ultra pack-efficient set for soloists.

- INCLUDES:**
- 0.75 L hard-anodized aluminum pot with insulated grip
 - 16 oz bowl
 - Lid with straining ports
 - Ultralight pot lifter
 - Room to nest PocketRocket® 2 stove and 4 oz fuel canister

Trail Mini™ Duo Cook Set

SKU 10375
MADE IN KOREA

Trail Mini™ Solo Cook Set

SKU 10374
MADE IN KOREA



Alpinist™ 2 Cook Set



Ultralight set for cooking basic meals and melting snow in remote places.

- INCLUDES:**
- 2.4 L hard-anodized aluminum pot w/strainer lid
 - 2 polypropylene DeepDish Plates
 - Talon Pot Handle
 - 2 polypropylene Insulated Mugs
 - Room for third mug or stove

Alpinist™ 2 Cook Set

SKU 06595
MADE IN THAILAND



Quick 2 Cook Set



Versatile 2-pot cook set for a range of cooking utility, serving two or more.

- INCLUDES:**
- 1.5 L hard-anodized nonstick aluminum pot
 - 2.5 L hard-anodized aluminum pot w/ strainer lid
 - Talon Pot Handle
 - 2 polypropylene DeepDish Plates
 - 2 polypropylene Insulated Mugs

Quick 2 Cook Set

SKU 06597
MADE IN THAILAND

STAINLESS STEEL

Simple, sophisticated and rugged, our stainless steel cookware is the most durable choice for frequent backcountry travelers, frontcountry campers and guides, whose gear needs to be able to take a lot of abuse.



Alpine™ StowAway™ Pots

Durable stainless steel pots with hinged handles for easy lifting and secure storage.

- Rugged stainless steel pots stand up to heavy use and campfire cooking
- Great for storing gear or supplies when not cooking
- Hinged, easy-lift handle flips over the fitted lid to lock it in place

Alpine™ StowAway™ Pots				
SIZE	475 ml	775 ml	1.1 L	1.6 L
SKU	321107	321108	321109	321111
MADE IN	THAILAND			



Alpine™ 4 Pot Set



Durable stainless steel cook set for preparing small group meals.

INCLUDES:

- 1 L, 2 L and 3 L stainless steel pots
- 3 lids that double as plates
- PanHandler™ Pot Lifter
- Stuff sack

Alpine™ 4 Pot Set	
SKU	21721
MADE IN	THAILAND



Alpine™ 2 Pot Set



Stainless steel durability in a weight-saving cook set for two or more.

INCLUDES:

- 1.5 L and 2 L stainless steel pots
- Lid
- PanHandler™ Pot Lifter
- Stuff sack

Alpine™ 2 Pot Set	
SKU	21720
MADE IN	THAILAND



Alpine™ Fry Pan

Featuring stainless steel durability for heavy use.

- Bimetal pan with folding handle
- Extra layer of metal on bottom to diffuse heat more evenly
- Nests over Alpine 3 L pots

Alpine™ Fry Pan	
SKU	21611
MADE IN	THAILAND



Alpine™ Plate

Strong, lightweight stainless steel plate.

- Nests with Alpine 2 L and 3 L pots

Alpine™ Plate	
SKU	321104
MADE IN	THAILAND



Alpine™ Long Tool Spoon

Extra-long spoon and stove maintenance tool in one.

- Durable stainless steel spoon
- Long handle to reach meals in tall pots and re-sealable stand-up pouches
- Integrated jet-and-cable tool for liquid-fuel stoves

Alpine™ Long Tool Spoon	
SKU	09523
MADE IN	THAILAND



Alpine™ Nesting Bowl

Rugged, space-saving stainless steel bowls.

- Bowls also fit inside Alpine 2 Pot Set

Nesting Bowl	
SKU	03138
MADE IN	THAILAND



Alpine™ Tool Spoon

Spoon and stove maintenance tool in one.

- Durable stainless steel spoon
- Integrated jet-and-cable tool for liquid-fuel stoves

Alpine™ Tool Spoon	
SKU	321102
MADE IN	THAILAND



Alpine™ Tool Fork

Fork and stove maintenance tool in one.

- Durable stainless steel fork
- Integrated jet-and-cable tool for liquid-fuel stoves

Alpine™ Tool Fork	
SKU	09522
MADE IN	THAILAND



TITANIUM

Our Titan™ titanium line is ideal for fast-and-light travelers who count every gram yet demand the ultralight strength of a premium material that's more durable than aluminum and 45% lighter than steel.



Titan™ Kettle

Ultralight titanium kettle for one—with pot, mug or bowl versatility.

- 0.85 L ultralight titanium kettle
- Lid

Titan™ Kettle	
SKU	321158
MADE IN	THAILAND



Titan™ 2-Pot Set

Ultralight titanium for those who scrutinize every gram. Our lightest 2-pot set.

INCLUDES:

- 1 L and 1.5 L Titanium Pots
- Titanium lid
- LiteLifter™ Pot
- Handle and stuff sack

Titan™ 2 Pot Set	
SKU	21722
MADE IN	THAILAND



Titan™ Tool Spoon

Ultralight titanium spoon and stove maintenance tool in one.

- Durable titanium spoon
- Integrated jet-and-cable tool for liquid-fuel stoves

Titan™ Tool Spoon	
SKU	321156
MADE IN	THAILAND



Big Titan™ Kettle

Ultralight titanium kettle with added volume for serving two—or for melting snow.

- Strong, lightweight & packable 2 L titanium kettle
- Lid

Big Titan™ Kettle	
SKU	09529
MADE IN	THAILAND



Titan™ Cup

Built to nest inside the Titan Kettle for the ultimate solo set.

- Ultralight titanium cup
- Folding wire handle

Titan™ Cup	
SKU	321160
MADE IN	THAILAND



Titan™ Fork & Spoon

Gram-counters' utensil set in ultralight titanium.

INCLUDES:

- 13 g (.46 oz) titanium fork
- 15 g (.5 oz) titanium spoon

Titan™ Fork & Spoon	
SKU	321150
MADE IN	THAILAND



CAMP KITCHEN

Find the utensils, dishware and food-prep products you need for eating well outdoors, whether you're deep in the backcountry or just off the trailhead.



Alpine™ Deluxe Kitchen Set

Comprehensive kitchen kit and deluxe carry case for basecamps and frontcountry use.

INCLUDES: Alpine Folding Utensil Set, Salt & Pepper Shaker, Dish Brush/Scraper, Kitchen Knife, Deluxe Cutting Board, Dish Towel, Bottle Opener/Corkscrew, Squeeze Bottles, Deluxe Case

Alpine™ Deluxe Kitchen Set	
SKU	05337
MADE IN	TAIWAN



Ultralight Kitchen Set

A lightweight kitchen set with utensils and accessories in one convenient package.

INCLUDES: Folding Spoon, Spatula, Ultralight Cutting Board, Salt & Pepper Shaker, Squeeze Bottle, Dish Towel

Ultralight Kitchen Set	
SKU	03140
MADE IN	TAIWAN



Alpine™ Dish Brush/Scraper

Fast-drying, mildew-resistant brush with custom-formed handle that doubles as a scraper.

Alpine™ Dish Brush/Scraper	
SKU	05331
MADE IN	TAIWAN



Alpine™ Deluxe Cutting Board

Hinged cutting board folds in half for packing. Available as part of Alpine Deluxe Kitchen Set or on its own.

Alpine™ Deluxe Cutting Board	
SKU	05340
MADE IN	TAIWAN



Alpine™ Kitchen Knife

All-purpose, hardened stainless steel utility knife with easy-to-clean plastic sheath.

Alpine™ Kitchen Knife	
COLOR	
SKU	07091
MADE IN	TAIWAN



Alpine™ Chef's Knife

Modified Santoku design with high-grade stainless steel excels at chopping and slicing.

Alpine™ Chef's Knife	
COLOR	
SKU	06924
MADE IN	TAIWAN



Alpine™ Salt/Pepper Shaker & Spice Shaker

Rugged, BPA-free containers with water-resistant lid, center divider & spice shaker cap.

	Salt/Pepper	Spice
SKU	05338	05339
MADE IN	TAIWAN	TAIWAN



Alpine™ Utensil Set

Convenient, folding, glove-friendly utensil set. Strainer doubles as a cheese grater.

Alpine™ Utensil Set	Alpine™ Spatula	Alpine™ Spoon	Alpine™ Grater-Strainer
SKU	05341	05342	05343
MADE IN	TAIWAN	TAIWAN	TAIWAN



MugMate™ Coffee / Tea Filter

A low-profile, reusable coffee/tea filter that can be stored in just about any mug or cup.

MugMate™ Coffee / Tea filter	
SKU	321003
MADE IN	GERMANY

CAMP KITCHEN



2 Person Mess Kit

A mess kit with color-matching bowls, mugs and utensils that easily nests inside the Trail Lite™ 2 L Pot.

INCLUDES: (2) Insulated Mugs, (2) DeepDish™ Bowls, (2) Folding Sporks, (1) Mesh Bag

2 Person Mess Kit	
SKU	03137
MADE IN	CHINA



DeepDish™ Plates

Wide plates that double as bowls and nest with our pots. Multiple color options.

SMALL: Nests in 2.4 - 2.5 L pots.
MEDIUM: Nests in 3 - 3.3 L pots.
LARGE: Nests in 5.3 L pot.

	Small DeepDish™ Plates	Medium DeepDish™ Plates	Large DeepDish™ Plates
COLOR			
SKU	05997	06003	06004
MADE IN	THAILAND		



Heat Exchanger

Increased heat efficiency & wind protection for all 1.5 L and 2 L MSR pots (excluding Titan™ 1.5 L pot).

Heat Exchanger	
SKU	321105
MADE IN	USA



DeepDish™ Bowl

Nests with our Trail Lite Duo Cook Set. Also fits neatly outside Reactor 1.7 L Pot.

DeepDish™ Bowl	
COLOR	
SKU	06599
MADE IN	CHINA



Folding Utensils

Locking mechanism allows for secure use in the open position. Multiple color options.

	Spoon	Fork	Spork	
COLOR				
SKU	06912	06590	06911	06908
4 Pc Spork Kit (1 each Red, Grey, Blue, Green)				03170
4 Pc Spoon & Fork Kit (2 each Red, Grey)				03169
MADE IN	IRELAND			



LiteLifter™

Safely lifts up to 2-liter pots of liquid and weighs only 28 g (1 oz).

LiteLifter™	
SKU	321182
MADE IN	THAILAND



PanHandler™

Pot lifter for all MSR cookware supports up to 4.5 kg (10 lb), comes with a Packtowl® sleeve.

PanHandler™	
SKU	13000
MADE IN	THAILAND

MSR® COOKWARE SPECIFICATIONS

COOK SETS	SKU	COMPONENTS	WEIGHT	PACKED SIZE DIAMETER x HEIGHT
Trail Lite™ Duo Cook Set	06897	2.0 L Hard-anodized aluminum pot, Clear strainer lid, (2) Insulated Mugs, (2) DeepDish™ Bowls	612 g (21.6 oz)	14.5 x 15.5 cm (5.7 x 6.1 in)
Trail Lite™ Solo Cook Set	10373	1.3 L Hard-anodized aluminum pot w/ strainer lid, Insulated Mug, DeepDish Bowl	360 g (12.7 oz)	14.5 x 10.2 cm (5.7 x 4 in)
Trail Mini™ Duo Cook Set	10375	1.2 L Hard-anodized aluminum pot w/ strainer lid, Insulated grip, Ultralight pot lifter, 28 oz bowl	289 g (10.2 oz)	12.7 x 14 cm (5.0 x 5.5 in)
Trail Mini™ Solo Cook Set	10374	0.75 L Hard-anodized aluminum pot w/ strainer lid, Insulated grip, Ultralight pot lifter, 16 oz bowl	203 g (7.2 oz)	10.2 x 12.2 cm (4 x 4.8 in)
Flex™ 4 Cook Set	05996	3.2 L Nonstick hard-anodized aluminum pot, 5.3 L Dual-handle hard-anodized aluminum pot, (2) Strainer lids, Talon Pot Handle, (4) DeepDish Plates, (4) Insulated Mugs	1666 g (58.8 oz)	23.6 x 15.2 cm (9.3 x 6 in)
Flex™ 3 Cook Set	05995	2.3 L Nonstick hard-anodized aluminum pot, 3.3 L Hard-anodized aluminum pot w/ strainer lid, Talon Pot Handle, (3) DeepDish Plates, (3) Insulated Mugs	1088 g (38.4 oz)	20.8 x 13 cm (8.2 x 5.1 in)
Alpinist™ 2 Cook Set	06595	2.4 L Hard-anodized aluminum pot w/ strainer lid, (2) DeepDish Plates, (2) Insulated Mugs, Talon Pot Handle	630 g (22.2 oz)	18.3 x 12.2 cm (7.2 x 4.8 in)
Quick 2 Cook Set	06597	1.5 L Nonstick hard-anodized aluminum pot, 2.5 L Hard-anodized aluminum pot w/ strainer lid, Talon Pot Handle, (2) Insulated Mugs, (2) DeepDish Plates	780 g (27.5 oz)	18.3 x 12.7 cm (7.2 x 5 in)
CERAMIC NONSTICK				
Ceramic Solo Pot	13230	1.3 L Fusion® ceramic nonstick aluminum pot w/ Strainer lid, Talon Pot Handle	213 g (7.5 oz)	15.7 x 9.7 cm (6.2 x 3.8 in)
Ceramic 2.5 L Pot	13231	2.5 L Fusion® ceramic nonstick aluminum pot w/ strainer lid, Talon Pot Handle	302 g (10.7 oz)	18.3 x 12.7 cm (7.2 x 5 in)
Ceramic 2-Pot Set	13232	1.5 L Fusion® ceramic nonstick aluminum pot, 2.5 L Ceramic nonstick aluminum pot w/ strainer lid, Talon Pot Handle	443 g (15.6 oz)	18.3 x 12.7 cm (7.2 x 5 in)
Ceramic Skillet	13233	Fusion® ceramic nonstick aluminum skillet, Talon Pot Handle	190 g (6.7 oz)	21.1 x 5.1 cm (8.3 x 2 in)
HARD ANODIZED				
Pika™ 1 L Teapot	10942	1 L hard anodized aluminum pot, with lid	147 g (5.2 oz)	14 x 8.9 cm (5.5 x 3.5 in)
Trail Lite 1.3 L Pot	13234	1.3 L hard anodized aluminum pot, with lid	201 g (7.1 oz)	14.5 x 15.5 cm (5.7 x 6.1 in)
Trail Lite 2.0 L Pot	13235	2 L hard anodized aluminum pot, with lid	249 g (8.8 oz)	14.5 x 10.2 cm (5.7 x 4 in)
Quick Skillet	05330	Nonstick hard-anodized aluminum sized to nest with our Quick 2, Base 2, and Ceramic 2.5 L Pot Sets. Includes Talon Pot Handle.	160 g (5.6 oz)	18.8 x 5.1 cm (7.4 x 2 in)
STAINLESS STEEL				
Alpine™ 4 Pot Set	21721	1 L Stainless steel pot w/ lid, 2 L Stainless steel pot w/ lid, 3 L Stainless steel pot w/ lid, PanHandler™ Pot Lifter	1109 g (39.1 oz)	22.9 x 11.9 cm (9 x 4.7 in)
Alpine™ 2 Pot Set	21720	1.5 L Stainless steel pot w/ plate lid, 2 L Stainless steel pot w/ plate lid, PanHandler Pot Lifter	604 g (21.3 oz)	19.3 x 11.2 cm (7.6 x 4.4 in)
Alpine™ StowAway Pots	475 ml: 321107 775 ml: 321108 1.1 L: 321109 1.6 L: 321111	Stainless steel with folding handles	270 g (9.5 oz) 365 g (13 oz) 440 g (15.5 oz) 550 g (19.5 oz)	11.7 x 7.6 cm (4.6 x 3 in) 14.2 x 8.6 cm (5.6 x 3.4 in) 16.5 x 9.7 cm (6.5 x 3.8 in) 18.3 x 10.2 cm (7.2 x 4 in)
Alpine™ Fry Pan	21611	Stainless steel fry pan w/ folding handle	312 g (11 oz)	19.6 x 4.8 cm (7.7 x 1.9 in)
TITANIUM				
Titan™ Kettle	321158	.85 L Titanium kettle w/ lid	118 g (4.2 oz)	11.7 x 9.7 cm (4.6 x 3.8 in)
Big Titan™ Kettle	09529	2 L Titanium kettle w/ lid	182 g (6.4 oz)	15.5 x 12.2 cm (6.1 x 4.8 in)
Titan™ 2 Pot Set	21722	1 L Titanium pot, 1.5 L Titanium pot w/ lid, Lite Lifter™ Pot Handle	272 g (9.6 oz)	16.5 x 10.7 cm (6.5 x 4.2 in)

**BACKED BY
SCIENCE.
TRUSTED BY
ADVENTURERS.**



PHOTO: SCOTT RINCKENBERGER

2021 LINE PLAN | WATER TREATMENT

<p>SE200™ COMMUNITY CHLORINE MAKER VIRUS PROTECTION</p>	<p>GUARDIAN™ PURIFIER VIRUS PROTECTION</p>	<p>GUARDIAN™ GRAVITY PURIFIER VIRUS PROTECTION</p>	<p>TRAILSHOTS™ MICROFILTER</p>	<p>THRU-LINK™ INLINE MICROFILTER</p>	<p>EMERGENCY HOME WATER FILTRATION SYSTEM</p>	<p>MINIWORKS™ EX PURIFIER SYSTEM VIRUS PROTECTION</p>	<p>HYPERFLOW™ MICROFILTER</p>	<p>MINIWORKS™ EX MICROFILTER</p>	<p>TRAIL BASE™ WATER FILTER KIT</p>	<p>AUTOFLOW™ XL GRAVITY FILTER 10L</p>	<p>AQUATABS® VIRUS PROTECTION</p>
			PERSONAL			PUMPS			GROUP/GRAVITY		
									MSR® WATER		



SAFE WATER STARTS WITH SCIENCE

WHY CHOOSE A PURIFIER? **MAXIMUM PROTECTION**

As more people visit popular wilderness sites with less regard for their waste, the risk of viruses increases. Yet, viruses are too small for microfilters to catch. A quality purifier provides adventurers with a higher degree of defense. Our advanced purifiers combat viruses, bacteria and protozoa, plus sediment, delivering one ultimate tool to do it all.

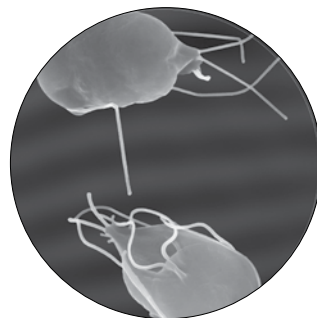

OUR WORLD-CLASS **RESEARCH, DESIGN & TESTING**

We invest in an on-site water lab with staff scientists, and individually test our devices to ensure they deliver greater safety and ease of use.

Every MSR hollow fiber filter and purifier features:

- **An integrity check** that allows the user to easily confirm that, if the device is dropped or frozen, the fibers haven't been damaged and the device is working safely—a feature most competitors don't provide.
- **An end-of-life indicator**—the filter media stops passing water. This clearly identifies that it's time to replace the cartridge without exposing the user to harmful pathogens.
- **Passes NSF Protocol P231** throughout the filter's life. The test confirms microbiological threat removal from a variety of water types, unlike NSF 42 and 53, which aren't suitable tests for backcountry use.



THE NSF PROTOCOL P231 **TESTING STANDARD**

Though backcountry water filters and purifiers are unregulated, NSF Protocol P231 provides a scientifically accepted standard for testing such devices. Every MSR design passes the stringent test when challenged with what's considered worst-case water (extreme levels of microbes, turbidity, etc.)—even at the end of its life. The standard is the best way to prove a device offers protection against real backcountry water types throughout its useful life.



Guardian™ Gravity Purifier

State-of-the-art, high-volume water purifier—the only gravity system you may ever need.

Using the revolutionary technologies of the original Guardian, this gravity-powered sibling delivers large volumes of purified water virtually anywhere on Earth. From hostels to basecamps to backcountry zones, its military-grade engineering and fast flow mean adventurers have the viral defense and safe water they need for drinking, cooking and hygiene.

- **Ultimate Two-Stage Protection:** Uses hollow fiber and activated carbon to remove viruses, protozoa, bacteria and microplastics, and reduce chemicals and tastes. Meets the more rigorous NSF protocol P248 military testing standard.
- **Easy to Fill:** 10 L reservoir fills easily at sinks and wild sources. Universal bottle adapter prevents cross-contamination.
- **High-Flow Cartridge:** Advanced engineering creates fast virus-removing gravity system (1L in 2 min).
- **No Backflushing:** Integrated purge valve quickly flushes system to clean it and maintain flow.
- **Built for Travel:** Rugged, military-grade construction; compact system fits easily in carry-on luggage and smaller packs.

Guardian™ Gravity Purifier	
SKU	13460
WEIGHT	532 g (18.7 oz)
HEIGHT	32 cm (12.5 in)
MAX DIAMETER	12 cm (4.7 in)
MADE IN	USA OF U.S. AND IMPORTED MATERIALS



PURIFICATION

Tested against some of the worst water, our purifiers deliver the viral defense adventurers need in high-risk zones, like popular wilderness areas and developing countries.



Guardian™ Purifier

The world's most advanced backcountry purifier.

- **Ultimate Protection:** Meets NSF protocol P248, testing standard used by U.S. military for removing viruses, protozoa, bacteria and sediment.
- **Self-Cleaning:** Patent-pending system self-cleans with each stroke, eliminating the need to ever backflush or filter-scrub to maintain flow.
- **Fast, Easy & Long-Lasting:** Purifies 2.5 liters per minute from nearly any source and treats up to 10,000 liters.
- **Rugged Construction:** Stands up to heavy use and extreme environments; hollow fibers withstand freezing.

Guardian™ Purifier	
SKU	02370
WEIGHT	490 g (17.3 oz)
HEIGHT	21 cm (8.2 in)
MAX DIAMETER	12 cm (4.7 in)
MADE IN	USA OF U.S. AND IMPORTED MATERIALS



MiniWorks® EX Purifier System

Our best-selling microfilter, with the added protection of Aquatabs® purification tablets.

- **Iodine-Free:** No unpleasant iodine taste or health risk.
- **Long-Lasting:** Durable ceramic element filters up to 2,000 liters; 50 tablets treat up to 95 liters.
- **Fast & Easy:** Pumps up to 1 liter per minute.
- **Ideal For:** Use in developing countries and popular wilderness areas.
- **Includes:** MiniWorks EX Microfilter and 50 Aquatabs purification tablets.
- **Safe:** Meets NSF protocol P231 for removal of bacteria and protozoa.

MiniWorks® EX Purifier System	
SKU	56431
MADE IN	USA OF U.S. AND IMPORTED MATERIALS
NOT AVAILABLE IN CANADA	

MICROFILTRATION

From our fast-and-light microfilters to our gravity-powered systems, we apply the latest technologies and rigorous testing to assure you safe water on every adventure.



Thru-Link™ Inline Microfilter

Inline ease and efficiency for big days, with fast filtering on the go.

- **Two-Stage Filtration:** Fast-flow hollow fiber removes pathogens, particulate & microplastics; activated carbon reduces chemicals, tastes and odors.
- **Fast:** Engineered specifically for inline filtration and high-flow drinking.
- **Universal Fit:** Quick-connects into any hydration reservoir.
- **Proven:** Used by the U.S. military for more than a decade.
- **Safe:** Rugged ultrasonic-welded ABS housing. Meets NSF protocol P231 for removal of bacteria and protozoa.

Thru-Link™ InLine Microfilter	
SKU	13236
WEIGHT	71 g (2.5 oz)
MADE IN	USA OF U.S. AND IMPORTED MATERIALS



TrailShot™ Microfilter

So small there's no excuse to leave it behind on fast-paced, all-day adventures.

- **Pocket-Sized & Light:** 142 g (5 oz) microfilter stashes in a pocket.
- **Drink from the Source:** Drink directly from water sources along the trail and refill multiple vessels.
- **Fast & Easy:** Quick-deploy design & simple squeezing action fills 1-liter bottles in 60 seconds.
- **Safe:** Hollow fiber filter meets NSF protocol P231 for removal of protozoa and bacteria. Treats up to 2,000 liters.

TrailShot™ Microfilter	
SKU	09385
WEIGHT	142 g (5 oz)
MADE IN	USA OF U.S. AND IMPORTED MATERIALS



HyperFlow™ Microfilter

Our fastest compact pump microfilter.

- **Super-Fast:** Pumps up to 3 liters per minute.
- **Ultralight:** Just 221 g (7.8 oz).
- **Field-Maintainable:** Can be cleaned repeatedly for flow recovery; no tools required for complete disassembly.
- **Adaptable:** Connects directly to Dromedary® and DromLite™ Bags, Hydromedary™ hydration systems and standard wide-mouth bottles.
- **Safe:** Hollow fiber filter meets NSF protocol P231 for removal of bacteria and protozoa.

HyperFlow™ Microfilter	
SKU	56500
MADE IN	USA OF U.S. AND IMPORTED MATERIALS

MiniWorks® EX

Durable microfilter for day hikes and expeditions. Our best-seller for over 20 years.

- **Long-Lasting:** Durable ceramic element filters up to 2,000 liters.
- **Solid Activated Carbon Core:** Reduces unpleasant tastes and odors, along with many chemical contaminants.
- **Field-Maintainable:** Can be cleaned repeatedly for full flow recovery; no tools required for complete disassembly.
- **Easy-to-Use:** Attaches to Dromedary Bags and wide-mouth bottles.
- **Safe:** Meets NSF protocol P231 for removal of bacteria and protozoa.

MiniWorks® EX	
SKU	56425
MADE IN	USA OF U.S. AND IMPORTED MATERIALS

MICROFILTRATION



Trail Base™ Water Filter Kit

Our most versatile backcountry filter system ever.

- **Versatile:** Transforms from a gravity system into a small trail filter and back, fast.
- **Easy Transitions:** Trail filter simply quick-connects into gravity system.
- **Complete Kit:** Includes ultralight clean-water reservoir with easy-pour cap.
- **Safe:** Hollow fiber filter meets NSF protocol P231 for removal of bacteria and protozoa.

Trail Base™ Water Filter Kit		
SIZE	2 L	4 L
SKU	10372	10943
WEIGHT	462 g (16.3 oz)	516 g (18.2 oz)
MADE IN	USA OF U.S. AND IMPORTED MATERIALS	

MUST HAVE



AutoFlow™ XL Gravity Filter 10 L

Fast, high-volume water filtration for groups and basecamps.

- **Fast:** Uses gravity to filter 1.75 liters per minute, letting you multi-task at camp.
- **Rugged:** Durable film reservoir with RF-welded seams.
- **Field-Maintainable:** Filter is easily cleaned in the field; no tools required.
- **Safe:** Hollow fiber filter meets NSF protocol P231 for removal of bacteria and protozoa.

AutoFlow™ XL Gravity Filter 10 L	
SIZE	10 L
SKU	10944
WEIGHT	340 g (12 oz)
MADE IN	USA OF U.S. AND IMPORTED MATERIALS

STORAGE

MSR's water hauling and storage bags are built to endure the rigors of backcountry and expedition travel. Each one is engineered for compact, efficient packing, and all the durability needed to keep this vital resource reliably at your fingertips.



DromLite™ Bags

Supremely packable water storage bags with the weight savings to match.

- **Extremely Compact:** High-capacity bag folds down to size of its cap for discreet storage.
- **Light:** Lightweight, durable film construction is perfect for fast-and-light travel.
- **Convenient Attachment:** Makes it easy to hang from packs or trees; set up as a basecamp reservoir or shower station.
- **Durable:** Made with rugged film and RF-welded seams.
- **Safe Drinking:** BPA-free.

DromLite™ Bags			
SIZE	2 L	4 L	6 L
SKU	09583	09584	09585
MADE IN	USA OF U.S. AND IMPORTED MATERIALS		

MUST HAVE



Dromedary® Bags

The world's burliest solution to collapsible backcountry water storage.

- **Heavy-Duty:** Abrasion-resistant, hydrophobic 1,000D fabric withstands freezing, boiling, and the abuse of expedition crews and hardcore adventurers.
- **Food-Grade Lining:** Ensures better tasting water.
- **Redesigned Cap:** Low-profile 3-in-1 cap lets you fill, drink and pour with ease.
- **Convenient Attachment:** Streamlined webbing and strategic grommets for pack attachment and hanging.
- **Safe Drinking:** BPA-free.

Dromedary® Bags			
SIZE	4 L	6 L	10 L
SKU	09586	09587	09588
MADE IN	USA OF U.S. AND IMPORTED MATERIALS		

EMERGENCY PREPAREDNESS



MSR's decades of R&D for the U.S. military and disaster relief have produced among the safest and most reliable water treatment solutions for families building peace-of-mind emergency kits.

Emergency Home Water Filtration System

Provides clean water in the wake of disaster, easily integrating with standard home spigots.

- **Always Ready:** Hermetically sealed packaging protects against the elements for long-term, reliable storage.
- **Two-Stage Filtration:** Hollow fiber membrane removes pathogens, particulate and microplastics; activated carbon reduces chemicals, tastes and odors.
- **Easy Fit:** Fits all standard-threaded outdoor spigots.
- **Safe:** Rugged ultrasonic-welded ABS housing. Meets NSF protocol P231 for removal of bacteria and protozoa.
- **Includes:** Thru-Link Filter, inlet hose with universal faucet adapter and female quick-connect (CPC), outlet hose with male quick-connect (CPC).

Emergency Home Water Filtration System	
SKU	13237
MADE IN	USA OF U.S. AND IMPORTED MATERIALS

SE200™ Community Chlorine Maker

Creates chlorine with the push of a button for high-volume water treatment. Perfect for emergency kits and remote basecamps.

- **Simple & Fast:** Turns a salt-and-water mixture into chlorine in five minutes.
- **High Volume Treatment:** Each batch makes enough chlorine to treat 200 liters (55 gal) of water.
- **Reliable:** Smart circuitry produces a consistent chlorine concentration for easy dosing.
- **Proven:** Currently supporting hundreds of thousands of people in low-resource countries and disaster relief efforts.

SE200™ Community Chlorine Maker	
SKU	10275
MADE IN	USA OF U.S. AND IMPORTED MATERIALS

TABLETS



Aquatabs®

MSR is proud to be a trusted distribution partner for this highly reputable product in the outdoor market.

- **Effective:** US EPA-registered in all 50 states; effective against viruses, bacteria and giardia cysts.
- **Fast:** 30-minute treatment time.
- **Efficient:** Each tablet treats up to 2 quarts of clear water.
- **Ideal For:** Ultralight backcountry travel, international travel, emergency kits.

30 tablet consumer pack	
SKU	00565
SIZE	Approx. 8 x 3.25 in (20 x 8 cm)
NOT AVAILABLE IN CANADA	

ACCESSORIES



TrailShot™ / Trail Base™ Replacement Filter Cartridge

Refreshes the flow rates of your TrailShot Microfilter or Trail Base Filter.

TrailShot™ / Trail Base™ Replacement Filter Cartridge

SKU 09592
MADE IN USA OF U.S. AND IMPORTED MATERIALS



Guardian™ Filter Cartridge Replacement

Replacement hollow fiber cartridge. Comes with clean-side cover.

Guardian™ Filter Replacement Cartridge

SKU 02407
MADE IN USA OF U.S. AND IMPORTED MATERIALS



Guardian™ Gravity Replacement Cartridge

Replacement cartridge with hollow fiber technology and activated carbon.

Guardian™ Gravity Replacement Cartridge

SKU 13469
MADE IN FRANCE



AutoFlow™ Replacement Cartridge

Replacement hollow fiber filter cartridge.

AutoFlow™ Replacement Cartridge

SKU 06201
MADE IN KOREA



HyperFlow™ Microfilter Cartridge Replacement

Refresh flow rates with a new hollow fiber filter cartridge.

HyperFlow™ Microfilter Cartridge Replacement

SKU 56506
MADE IN KOREA



MiniWorks® / WaterWorks Ceramic Element

Replacement element provides increased flow rate for older models.

MiniWorks® / WaterWorks Ceramic Element

SKU 56453
MADE IN USA OF U.S. AND IMPORTED MATERIALS



Guardian™ Annual Maintenance Kit

Ensures years of lasting and reliable performance.

Guardian™ Annual Maintenance Kit

SKU 02405
MADE IN USA OF U.S. AND IMPORTED MATERIALS



HyperFlow™ Microfilter Maintenance Kit

For periodic maintenance.

HyperFlow™ Microfilter Maintenance Kit

SKU 56508
MADE IN CHINA



MiniWorks® / WaterWorks Maintenance Kit

For periodic maintenance.

MiniWorks® / Waterworks Maintenance Kit

SKU 56002
MADE IN USA OF U.S. AND IMPORTED MATERIALS



Hydration Kit

Converts any Dromedary® or DromLite™ bag into a hands-free hydration system.

Hydration Kit

SKU 57060
MADE IN USA OF U.S. AND IMPORTED MATERIALS



3-in-1 Cap

Low profile 3-in-1 cap lets you fill, drink, and pour with greater ease.

3-in-1 Cap

SKU 09589
MADE IN TAIWAN

MSR® WATER TREATMENT SPECIFICATIONS

Model	AutoFlow™ XL Gravity Filter 10 L	Guardian™ Gravity Purifier	Trail Base™ Water Filter Kit	Guardian™ Purifier	TrailShot™ Microfilter	HyperFlow™ Microfilter	MiniWorks® EX	MiniWorks® EX Purifier System	SE200	Thru-Link™
SKU	10944	13460	2 L / 4 L 10372 / 10943	02370	09385	56500	56425	56431	10275	13236
PHYSICAL SPECS										
Weight	340 g (12 oz)	532 g (18.7 oz)	2 L 462 g (16.3 oz) 4 L 516 g (18.2 oz)	490 g (17.3 oz)	142 g (5 oz)	221 g (7.8 oz)	456 g (16 oz)	456 g (16 oz)	836 g (29.5 oz)	71 g (2.5 oz)
Dimensions	30.5 x 12.7 cm (12 x 5 in)	32 x 12 cm (12.5 x 4.7 in)	30.5 x 12.7 cm (12 x 5 in)	21 x 11 cm (8.2 x 4.4 in)	15.25 x 6.1 cm (6 x 2.4 in)	17.8 x 8.3 cm (7 x 3.5 in)	19 x 7 cm (7.5 x 2.75 in)	19 x 7 cm (7.5 x 2.75 in)	27.3 x 23.5 cm (10.75 x 9.25 in)	4.1 x 19 cm (1.6 x 7.5 in)
Filter Matrix	Hollow Fiber	Hollow Fiber	Hollow Fiber	Hollow Fiber	Hollow Fiber	Hollow Fiber	Ceramic	Ceramic	N/A	Hollow Fiber
Filter Pore Size	0.2 Micron	0.02 Micron	0.2 Micron	0.02 Micron	0.2 Micron	0.2 Micron	0.2 Micron	0.2 Micron	N/A	0.2 Micron
EFFECTIVE AGAINST										
Protozoa	✓	✓	✓	✓	✓	✓	✓	✓	✓	✓
Bacteria	✓	✓	✓	✓	✓	✓	✓	✓	✓	✓
Viruses	NO	✓	NO	✓	NO	NO	NO	✓	✓	NO
Particulate	✓	✓	✓	✓	✓	✓	✓	✓	NO	✓
Taste/Odor	NO	✓	NO	NO	NO	NO	✓	✓	NO	✓
PERFORMANCE										
Flow (liters per minute)	1.75 Liter per Minute	0.45 Liter per Minute	1 Liter per Minute	2.5 Liters per Minute	1 Liter per Minute	3 Liters per Minute	1 Liter per Minute	1 Liter per Minute	N/A	1.2 Liter per Minute
Flow (strokes per liter)	N/A	N/A	N/A	30-35	N/A	20	80-90	80-90	N/A	N/A
Cartridge Life	1500 Liters	3000+ Liters	1500 Liters	10,000+ Liters	2000 Liters	1000 Liters	2000 Liters	2000 Liters	N/A	1000 Liters
Field Cleanable	✓	Purge Valve	✓	Self-Cleaning	✓	✓	✓	✓	N/A	✓
Field Maintainable	✓	N/A	✓	✓	✓	✓	✓	✓	N/A	N/A
EXTRAS/FEATURES										
Pump	NO	NO	✓	✓	✓	✓	✓	✓	NO	NO
Gravity	✓	✓	✓	NO	NO	NO	NO	NO	NO	✓
Water Bottle Adapter	✓	✓	NO	✓	NO	✓	✓	✓	NO	NO
End of Life Indicator	✓	✓	✓	✓	✓	✓	✓	✓	N/A	✓

MSR® DROMEDARY BAGS SPECIFICATIONS

DROMLITE™ BAGS	VOLUME	SKU	WEIGHT	DIMENSIONS
	2 Liters	09583	130 g (4.6 oz)	22 x 40 cm (8.5 x 15.6 in)
	4 Liters	09584	145 g (5.1 oz)	25.4 x 46.5 cm (10 x 18.3 in)
	6 Liters	09585	162 g (5.7 oz)	28.7 x 52.3 cm (11.3 x 20.6 in)
DROMEDARY® BAGS	VOLUME	SKU	WEIGHT	DIMENSIONS
	4 Liters	09586	196 g (6.9 oz)	25.4 x 46.5 cm (10 x 18.3 in)
	6 Liters	09587	247 g (8.7 oz)	28.7 x 52.3 cm (11.3 x 20.6 in)
	10 Liters	09588	284 g (10 oz)	31.8 x 58.4 cm (12.5 x 23 in)

PUSHING THE BOUNDS OF INNOVATION AND ADVENTURE



PHOTO: SCOTT RINCKENBERGER

2021 LINE PLAN | TENTS & SHELTERS

Category	Models
ALL-SEASON	H.U.B.™, REMOTE™ SERIES, ADVANCE PRO™ 2, FRONT RANGETM SERIES, PRO BIVY™
BACKPACKING	CARBON REFLEX™ SERIES, FREELITE™ SERIES, HUBBA NX™ SERIES, ELIXIR™ SERIES, ZOIC™ SERIES
FRONTCOUNTRY	HABITUDE™ SERIES, RENDEZVOUS™ SERIES
MINIMALIST	THRU-HIKER MESH HOUSE SERIES, THRU-HIKER WINGS SERIES, E-BIVY™

CAMPING/ FRONTCOUNTRY

Durable and extra-spacious tents that combine backcountry reliability with frontcountry comfort on everything from rafting trips to family campouts.

HABITUDE™ 4
HABITUDE™ 6



PHOTO: SCOTT RINCKENBERGER

HABITUDE™ SERIES

Parents seeking to pass their love of the outdoors on to their children now have a home base for just that. Built strong, Habitude tents hold up to family adventures and foul weather (no toppling in wind). And their expansive, standing-height interiors keep everyone—even pint-sized explorers—happy and comfortable.

STANDING-HEIGHT

High ceiling and vertical sidewalls let everyone move about comfortably, lounge and stand up to change. Door pocket allows for wide, easy entry.

STRONG

Robust fabrics, super-sturdy pole geometry, and smooth-glide YKK stainless steel zippers all endure rough use, little fingers, and challenging environments like sand, wind and rain.

EASY TO PITCH

Sets up quickly by one person (or one plus a small helper) thanks to hubbed poles, large, color-coded pole clips and a simple design.

UNPARALLELED LIVABILITY

Integrated porch light for easy night entry; storage pockets for each occupant; lots of hang loops; strategic mesh for airflow and blocking out cold nights; enormous vestibule.



Habitude™ 4

Strong, roomy, standing-height retreat for adventurous families and groups of four.

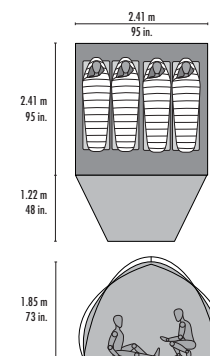

Habitude™ 4

CAPACITY	4
MIN. WEIGHT	5.44 kg (12 lb)
FLOOR + VESTIBULE	5.8 + 2.18 sq m (62.4 + 23.5 sq ft)
INTERIOR PEAK HEIGHT	1.85 m (73 in)
POLES	3 7000 Series Aluminum
FABRICS	
RAINFLY	68D ripstop polyester 1500mm Polyurethane & DWR
CANOPY	68D taffeta polyester & DWR
FLOOR	68D taffeta polyester 10,000mm Polyurethane & DWR

SKU

HABITUDE 4	13128
FOOTPRINT	13300
MADE IN	IMPORTED

Habitude™ 6

The “backpacker”-parents’ cabin in the woods, with plenty of space to comfortably sleep six.

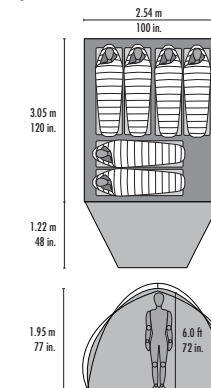

Habitude™ 6

CAPACITY	6
MIN. WEIGHT	6.08 kg (13 lb 6 oz)
FLOOR + VESTIBULE	7.71 + 2.27 sq m (83 + 24.5 sq ft)
INTERIOR PEAK HEIGHT	1.95 m (77 in)
POLES	3 7000 Series Aluminum
FABRICS	
RAINFLY	68D ripstop polyester 1500mm Polyurethane & DWR
CANOPY	68D taffeta polyester & DWR
FLOOR	68D taffeta polyester 10,000mm Polyurethane & DWR

SKU

HABITUDE 6	13129
FOOTPRINT	13301
MADE IN	IMPORTED

BACKPACKING TENTS

Lightweight and ultra-livable 3-season tents designed for backpackers and adventurers who pursue all kinds of activities.

ELIXIR™ SERIES

The most livable performance backpacking tent in its class. The Elixir tent is an ideal option for backpackers seeking easy-to-assemble tents at a great value.

LIVABLE

Extra-large vestibules, built-in gear lofts, StayDry™ doors, and glow-in-the-dark zippers make these tents ultra-livable. Unique pole geometry optimizes head room.

EASY SETUP

Designed with laser-etched, directional pole-end grommets, these freestanding tents feature color-coded poles, clips and webbing for fast and easy setup.

IDEAL COVERAGE

Mesh and solid fabric panels offer ventilation, warmth and privacy. Adaptable rainfly offers excellent views when you want them.



FOOTPRINT INCLUDED

Elixir™ 1

The most livable solo backpacking tent in its class.

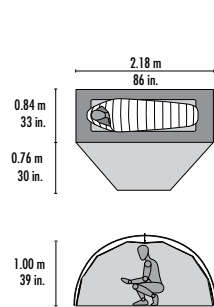

Elixir™ 1	
CAPACITY	1
MIN. WEIGHT	1.78 kg (3 lb 15 oz)
FLOOR+VESTIBULE	1.86 + 1.11 sq m (20 + 12 sq ft)
LIVABLE VOLUME	793 + 340 L (28 + 12 cu ft)
INTERIOR PEAK HEIGHT	1.00 m (39 in)
POLES	2 7000 Series Aluminum
FABRICS	
RAINFLY	68D ripstop polyester 1500mm Polyurethane & DWR
CANOPY	40D ripstop nylon DWR / 20D Micromesh
FLOOR	70 taffeta nylon 3000mm polyurethane & DWR
SKU	
ELIXIR 1	10310
MADE IN	
	IMPORTED

FOOTPRINT INCLUDED

Elixir™ 2

The perfect tent for two, with two large doors & vestibules and two gear lofts.

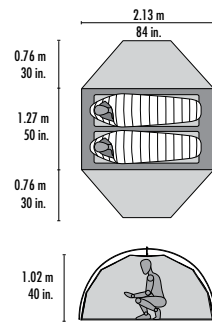

Elixir™ 2	
CAPACITY	2
MIN. WEIGHT	2.24 kg (5 lb)
FLOOR+VESTIBULE	2.69 + 2.22 sq m (29 + 24 sq ft)
LIVABLE VOLUME	1274 + 708 L (45 + 25 cu ft)
INTERIOR PEAK HEIGHT	1.02 m (40 in)
POLES	2 7000 Series Aluminum
FABRICS	
RAINFLY	68D ripstop polyester 1500mm Polyurethane & DWR
CANOPY	40D ripstop nylon DWR / 20D Micromesh
FLOOR	70 taffeta nylon 3000mm polyurethane & DWR
SKU	
ELIXIR 2	10311
MADE IN	
	IMPORTED



FOOTPRINT INCLUDED

Elixir™ 3

Maximum floor space lets you comfortably fit three mattresses side-by-side.

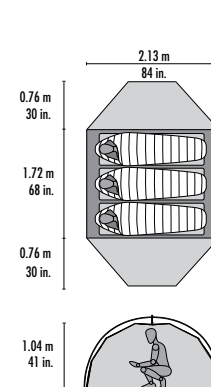

Elixir™ 3	
CAPACITY	3
MIN. WEIGHT	2.66 kg (5 lb 14 oz)
FLOOR+VESTIBULE	3.67 + 2.22 sq m (39.5 + 24 sq ft)
LIVABLE VOLUME	1784 + 708 L (63 + 25 cu ft)
INTERIOR PEAK HEIGHT	1.04 m (41 in)
POLES	2 7000 Series Aluminum
FABRICS	
RAINFLY	68D ripstop polyester 1500mm Polyurethane & DWR
CANOPY	40D ripstop nylon DWR / 20D Micromesh
FLOOR	70 taffeta nylon 3000mm polyurethane & DWR
SKU	
ELIXIR 3	10312
MADE IN	
	IMPORTED

FOOTPRINT INCLUDED

Elixir™ 4

Spacious tent for four includes storm-ready, pre-attached rainfly guy lines.

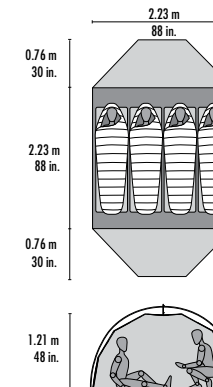

Elixir™ 4	
CAPACITY	4
MIN. WEIGHT	3.60 kg (7 lb 15 oz)
FLOOR+VESTIBULE	5.02 + 2.27 sq m (54 + 24.5 sq ft)
LIVABLE VOLUME	3285 + 850 L (116 + 30 cu ft)
INTERIOR PEAK HEIGHT	1.21 m (48 in)
POLES	2 7000 Series Aluminum
FABRICS	
RAINFLY	68D ripstop polyester 1500mm Polyurethane & DWR
CANOPY	40D ripstop nylon DWR / 20D Micromesh
FLOOR	70 taffeta nylon 3000mm polyurethane & DWR
SKU	
ELIXIR 4	10313
MADE IN	
	IMPORTED

BACKPACKING TENTS

Elixir™ Accessory



Gear Shed

Increases the vestibule area of most Elixir and Hubba NX series tents.

- Fits Elixir 1, 2, 3 and Hubba NX, Hubba Hubba NX and Mutha Hubba NX
- Hooped vestibule expands the weatherproof coverage
- Partial floor keeps critical gear clean and dry
- Turns your backpacking tent into a basecamp tent

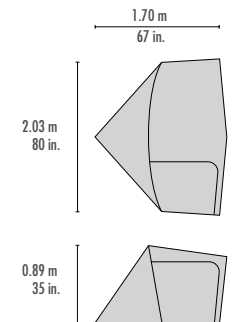

Gear Shed	
Gear	
Weight	.82 kg (1 lb 13 oz)
Floor Area	2.46 sq m (26.5 sq ft)
Volume	651 L (23 cu ft)
Height	.89 m (35 in)
POLES	1 7000 Series Aluminum
FABRICS	
RAINFLY	68D ripstop polyester 1500mm Polyurethane & DWR
CANOPY	70D taffeta nylon 3000mm polyurethane & DWR
SKU	
GEAR SHED	10314
MADE IN	
	IMPORTED

Casual backpackers and weekend warriors can stay cool and comfortable on warm nights in the wilderness with this ultra-breathable, spacious tent designed to help them rest up for more productive days of adventuring. Light enough to take into the backcountry, the Zoic tent can go from trailhead camping to remote mountain lakes with ease, and its easy-pitch design allows for more time to hang out with friends or to enjoy the scenery.

LIGHT

Full micromesh canopy offers max breathability, moisture control, star-gazing and bug-free protection, with minimal weight.

SPACIOUS

A wide floor plan and steep sidewalls create a roomier interior than traditional backpacking tents.

EASY SETUP

Freestanding system; hubbed pole allows for quick setup.

DURABLE

Proven MSR design geometry is matched with light, strong aluminum poles and long-lasting Xtreme Shield™ coating.

LIVABILITY

Included performance features, built-in gear lofts and extra volume make this tent an excellent value.



Zoic™ 1

Lightweight & breathable solo tent for warm-weather exploits.



Zoic™ 2

Two doors, two vestibules and two gear lofts make this lightweight tent extra livable.



Zoic™ 3

More room & gear lofts for three make backcountry adventures comfortable for all.

Zoic™ 4

A mountain mansion for bona fide backpacking families & groups.

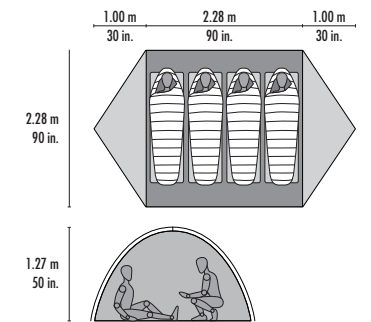
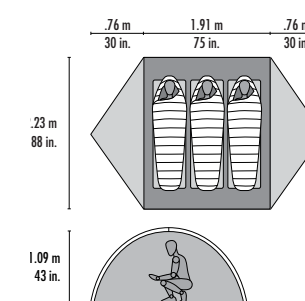
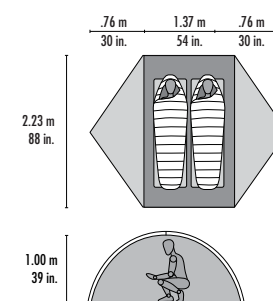
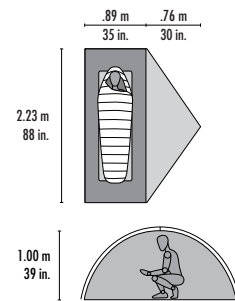

	Zoic™ 1
CAPACITY	1
MIN. WEIGHT	1.5 kg (3 lb 5 oz)
FLOOR + VESTIBULE	1.99 + .84 sq m (21.5 + 9 sq ft)
LIVABLE VOLUME	963 + 270 L (34 + 9.5 cu ft)
INTERIOR PEAK HEIGHT	1.00 m (39 in)
POLES	2 7000 Series Aluminum
FABRICS	
RAINFLY	40D ripstop nylon 1500mm Xtreme Shield™ polyurethane & silicone
CANOPY	15D nylon micromesh
FLOOR	70D taffeta nylon 3000mm Xtreme Shield™ polyurethane & DWR
SKU	
ZOIC 1	10892
FOOTPRINT	13009
MADE IN	IMPORTED

	Zoic™ 2
CAPACITY	2
MIN. WEIGHT	1.97 kg (4 lb 6 oz)
FLOOR + VESTIBULE	3.07 + 1.67 sq m (33 + 18 sq ft)
LIVABLE VOLUME	1529 + 539 L (54 + 19 cu ft)
INTERIOR PEAK HEIGHT	1.00 m (39 in)
POLES	2 7000 Series Aluminum
FABRICS	
RAINFLY	40D ripstop nylon 1500mm Xtreme Shield™ polyurethane & silicone
CANOPY	15D nylon micromesh
FLOOR	70D taffeta nylon 3000mm Xtreme Shield™ polyurethane & DWR
SKU	
ZOIC 2	10893
FOOTPRINT	13011
MADE IN	IMPORTED

	Zoic™ 3
CAPACITY	3
MIN. WEIGHT	2.45 kg (5 lb 7 oz)
FLOOR + VESTIBULE	4.27 + 1.67 sq m (46 + 18 sq ft)
LIVABLE VOLUME	2888 + 539 L (102 + 19 cu ft)
INTERIOR PEAK HEIGHT	1.09 m (43 in)
POLES	2 7000 Series Aluminum
FABRICS	
RAINFLY	40D ripstop nylon 1500mm Xtreme Shield™ polyurethane & silicone
CANOPY	15D nylon micromesh
FLOOR	70D taffeta nylon 3000mm Xtreme Shield™ polyurethane & DWR
SKU	
ZOIC 3	10894
FOOTPRINT	13013
MADE IN	IMPORTED

	Zoic™ 4
CAPACITY	4
MIN. WEIGHT	3.06 kg (6 lb 12 oz)
FLOOR + VESTIBULE	5.20 + 1.71 sq m (56 + 18.5 sq ft)
LIVABLE VOLUME	4585 + 552 L (162 + 19.5 cu ft)
INTERIOR PEAK HEIGHT	1.27 m (50 in)
POLES	2 7000 Series Aluminum
FABRICS	
RAINFLY	40D ripstop nylon 1500mm Xtreme Shield™ polyurethane & silicone
CANOPY	15D nylon micromesh
FLOOR	70D taffeta nylon 3000mm Xtreme Shield™ polyurethane & DWR
SKU	
ZOIC 4	13126
FOOTPRINT	13135
MADE IN	IMPORTED

HUBBA™ NX SERIES

Now our ultra-livable, lightweight freestanding Hubba tents come with virtually indestructible Easton® Syclone™ poles* and feature our ultra-durable Xtreme Shield™ waterproof coating, which lasts up to 3x longer than standard coatings.

LIGHTWEIGHT

Featuring lightweight fabrics and tent poles and weight-saving designs, Hubba NX series tents help keep packs light.

LIVABLE

Unique pole configuration maximizes head and elbow room; mesh canopies and adjustable, cross-ventilating rainfly offers optimal airflow and unrestricted views; large StayDry™ doors, large side entry vestibules.**

EASY SETUP & PACKING

Unified hub-and-pole system is ultra-compact.

*Easton® and Syclone™ trademarks are owned by Easton® Technical Products.

**Add an optional Gear Shed to double the storage space.



Hubba™ NX

Our best-selling freestanding solo tent.

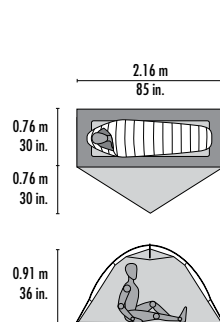

Hubba Hubba™ NX

Our best-selling, award-winning freestanding 2-person tent.

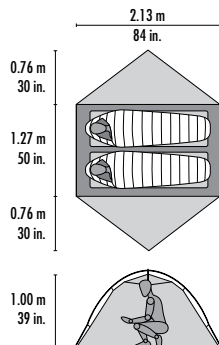

	Hubba™ NX
CAPACITY	1
MIN. WEIGHT	1.12 kg (2 lb 7 oz)
FLOOR + VESTIBULE	1.67 + .84 sq m (18 + 9 sq ft)
LIVABLE VOLUME	736 + 241 L (26 + 8.5 cu ft)
INTERIOR PEAK HEIGHT	.91 m (36 in)
POLES	1 Easton® Syclone™
FABRICS	
RAINFLY	20D ripstop nylon Xtreme Shield™ 1200 mm & silicone
CANOPY	15D nylon micromesh / 20D ripstop nylon
FLOOR	30D ripstop nylon XtremeShield™ 3000 mm
SKU	
HUBBA NX	10315
FOOTPRINT	13008
MADE IN	IMPORTED

	Hubba Hubba™ NX
CAPACITY	2
MIN. WEIGHT	1.60 kg (3 lb 8 oz)
FLOOR + VESTIBULE	2.69 + 1.62 sq m (29 + 17.5 sq ft)
LIVABLE VOLUME	1217 + 481 L (43 + 17 cu ft)
INTERIOR PEAK HEIGHT	1.00 m (39 in)
POLES	1 Easton® Syclone™
FABRICS	
RAINFLY	20D ripstop nylon Xtreme Shield™ 1200 mm & silicone
CANOPY	15D nylon micromesh / 20D ripstop nylon
FLOOR	30D ripstop nylon XtremeShield™ 3000 mm
SKU	
HUBBA HUBBA NX	10316
FOOTPRINT	13010
MADE IN	IMPORTED



Mutha Hubba™ NX

Extremely livable tent with optimized floor space and headroom for three.

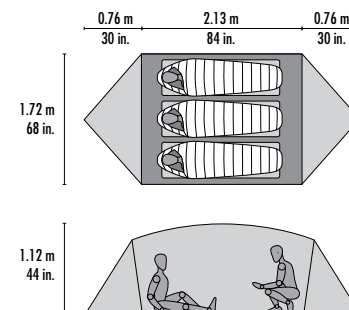

	Mutha Hubba™ NX
CAPACITY	3
MIN. WEIGHT	1.95 kg (4 lb 5 oz)
FLOOR + VESTIBULE	3.67 + 1.30 sq m (39 + 14 sq ft)
LIVABLE VOLUME	2290 + 453 L (81 + 16 cu ft)
INTERIOR PEAK HEIGHT	1.12 m (44 in)
POLES	1 Easton® Syclone™
FABRICS	
RAINFLY	20D ripstop nylon 1200mm Xtreme Shield™ polyurethane & silicone
CANOPY	15D nylon micromesh / 20D ripstop nylon & DWR
FLOOR	30D ripstop nylon 3000mm XtremeShield™ polyurethane & DWR
SKU	
MUTHA HUBBA NX	10317
FOOTPRINT	13012
MADE IN	IMPORTED

BACKPACKING TENTS

Hubba NX™ Accessory



Gear Shed

Increases the vestibule area of most Elixir and Hubba NX series tents.

- Fits Elixir 1, 2, 3 and Hubba NX, Hubba Hubba NX and Mutha Hubba NX
- Hooped vestibule expands the weatherproof coverage
- Partial floor keeps critical gear clean and dry
- Turns your backpacking tent into a basecamp tent

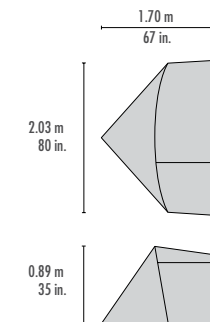

	SKU
Gear Shed	
Gear	
.82 kg (1 lb 13 oz)	
2.46 sq m (26.5 sq ft)	
651 L (23 cu ft)	
.89 m (35 in)	
1 7000 Series Aluminum	
SKU	
GEAR SHED	10314
MADE IN	IMPORTED

FREELITE™ SERIES

When weight is a critical factor but livability also matters in your choice of a tent, our ultralight FreeLite tents are the ideal choice and your best option for a weekend backcountry trip or two-week thru-hike.

ULTRALIGHT PROTECTION

Our lightest semi-freestanding double-wall tents provide full protection without a big weight penalty.

EASY ACCESS

Large doors provide easy access for convenience on longer backpacking trips. Interiors fit a large camping pad per occupant.

VENTILATION

Micromesh canopies offer maximum ventilation and moisture control along with bug-free protection.

DURABLE PROTECTION

Easton® Syclone™ poles* are virtually indestructible, and our Xtreme Shield™ waterproof coating lasts up to 3 times longer than standard coatings.

*Easton® and Syclone™ trademarks are owned by Easton® Technical Products.



FreeLite™ 1

Our lightest semi-freestanding backpacking tent for one.

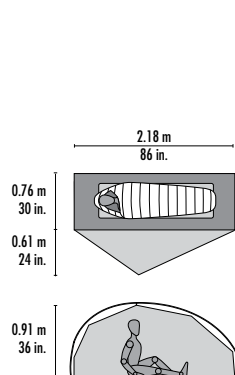

FreeLite™ 2

Two large doors and extra room makes this tent perfect for two.

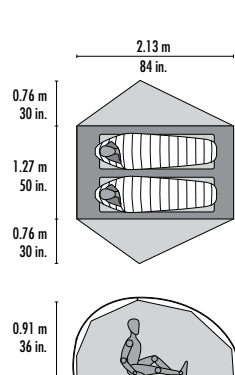

FreeLite™ 3

Comfortably fits three backpackers, but light enough for two to pack.

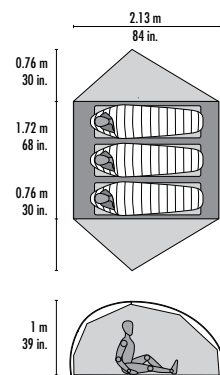

	FreeLite™ 1
CAPACITY	1
MIN. WEIGHT	0.9 kg (2 lb)
FLOOR + VESTIBULE	1.67 + .83 sq m (18 + 9 sq ft)
LIVABLE VOLUME	651 + 198 L (23 + 7 cu ft)
INTERIOR PEAK HEIGHT	.91 m (36 in)
POLES	1 Easton Syclone
FABRICS	
RAINFLY	15D ripstop nylon 1200mm Xtreme Shield polyurethane & silicone
CANOPY	10D polyester micromesh
FLOOR	15D Ripstop Nylon 1200mm Xtreme Shield polyurethane & DWR
SKU	
FREELITE 1	10325
FOOTPRINT	13008
MADE IN	IMPORTED

	FreeLite™ 2
CAPACITY	2
MIN. WEIGHT	1.14 kg (2 lb 8 oz)
FLOOR + VESTIBULE	2.69 + 1.62 sq m (29 + 17.5 sq ft)
LIVABLE VOLUME	850 + 410 L (30 + 14.5 cu ft)
INTERIOR PEAK HEIGHT	.91 m (36 in)
POLES	1 Easton Syclone
FABRICS	
RAINFLY	15D ripstop nylon 1200mm Xtreme Shield polyurethane & silicone
CANOPY	10D polyester micromesh
FLOOR	15D Ripstop Nylon 1200mm Xtreme Shield polyurethane & DWR
SKU	
FREELITE 2	10326
FOOTPRINT	13010
MADE IN	IMPORTED

	FreeLite™ 3
CAPACITY	3
MIN. WEIGHT	1.34 kg (2 lb 15 oz)
FLOOR + VESTIBULE	3.67 + 1.62 sq m (39.5 + 17.5 sq ft)
LIVABLE VOLUME	1330 + 410 L (47 + 14.5 cu ft)
INTERIOR PEAK HEIGHT	1.00 m (39 in)
POLES	1 Easton Syclone
FABRICS	
RAINFLY	15D ripstop nylon 1200mm Xtreme Shield polyurethane & silicone
CANOPY	10D polyester micromesh
FLOOR	15D Ripstop Nylon 1200mm Xtreme Shield polyurethane & DWR
SKU	
FREELITE 3	10327
FOOTPRINT	13012
MADE IN	IMPORTED

CARBON REFLEX™ SERIES

Lighter than our freestanding backpacking tents, our Carbon Reflex tents offer backpackers double-wall protection, 3-season livability and superior packability. Weight-saving fabrics and features, including a zipper-less vestibule entry, make these tents as light as a tarp.

ULTRALIGHT

Lightweight fabrics, Easton® Carbon ION™ poles* and zipper-free vestibules minimize weight.

FULL-FEATURED LIVABILITY

The weight of a tarp with the protection, setup ease and livability of a tent. Spacious interiors, mesh storage pockets, and ultra-durable Xtreme Shield™ waterproof coating on floor.

*Easton® and ION™ trademarks are owned by Easton® Technical Products.



Carbon Reflex™ 1

Our lightest full-protection solo tent.

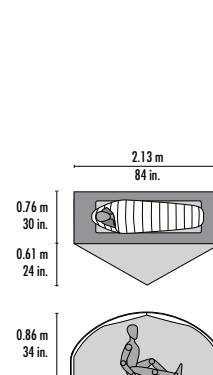

Carbon Reflex™ 2

Two doors offer easy access in our lightest double-walled, full-protection tent for two.

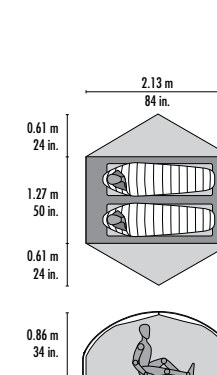

Carbon Reflex™ 3

Full-protection, featherweight livability for three.

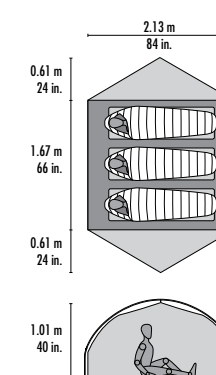

	Carbon Reflex™ 1
CAPACITY	1
MIN. WEIGHT	.66 kg (1 lb 7 oz)
FLOOR + VESTIBULE	1.63 + .65 sq m (17.5 + 7 sq ft)
LIVABLE VOLUME	651 + 190 L (23 + 7 cu ft)
INTERIOR PEAK HEIGHT	.86 m (34 in)
POLES	2 Easton Carbon ION
FABRICS	
RAINFLY	7D ripstop nylon DuraShield™ 1200 mm silicone
CANOPY	10D polyester micromesh
FLOOR	15D nylon Xtreme Shield™ 1200 mm & DWR
SKU	
CARBON REFLEX 1	10322
FOOTPRINT	13008
MADE IN	IMPORTED

	Carbon Reflex™ 2
CAPACITY	2
MIN. WEIGHT	.84 kg (1 lb 13 oz)
FLOOR + VESTIBULE	2.69 + 1.30 sq m (29 + 14 sq ft)
LIVABLE VOLUME	1217 + 382 L (43 + 13.5 cu ft)
INTERIOR PEAK HEIGHT	.86 m (34 in)
POLES	2 Easton Carbon ION
FABRICS	
RAINFLY	7D ripstop nylon DuraShield™ 1200 mm silicone
CANOPY	10D polyester micromesh
FLOOR	15D nylon Xtreme Shield™ 1200 mm & DWR
SKU	
CARBON REFLEX 2	10323
FOOTPRINT	13010
MADE IN	IMPORTED

	Carbon Reflex™ 3
CAPACITY	3
MIN. WEIGHT	1.03 kg (2 lb 4 oz)
FLOOR + VESTIBULE	3.58 + 1.30 sq m (38.5 + 14 sq ft)
LIVABLE VOLUME	1444 + 425 sq m (51 + 15 cu ft)
INTERIOR PEAK HEIGHT	1.01 m (40 in)
POLES	2 Easton Carbon 6.3
FABRICS	
RAINFLY	7D ripstop nylon DuraShield™ 1200 mm silicone
CANOPY	10D polyester micromesh
FLOOR	15D nylon Xtreme Shield™ 1200 mm & DWR
SKU	
CARBON REFLEX 3	10324
FOOTPRINT	13012
MADE IN	IMPORTED



Our Access tents let you spend comfortable days in the winter backcountry without hauling around heavy mountaineering tents. Lighter than our mountaineering tents and warmer than our backpacking tents, these strong tents provide skiers, splitboarders and snowshoers with a robust home base for their mountain pursuits.

STRONG DESIGN

Featuring a swivel pole hub for faster setup, the tents' central support frame holds up to high winds and heavy snow loads. Virtually unbreakable Easton® Syclone™ Poles further boost durability.

RELIABLE PROTECTION

Durable fabrics offer full protection and warmth in cold weather and in snow conditions found at tree line.

LIVABILITY

Rainfly vents reduce condensation, while large vestibules protect gear, freeing up more livable room inside the tent.



Access™ 1

The best solo tent for winter backcountry trips.

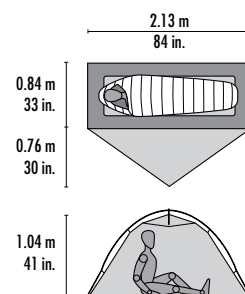

Access™ 1	
CAPACITY	1
MIN. WEIGHT	1.37 kg (3 lb)
FLOOR + VESTIBULE	1.76 + .23 sq m (19 + 9 sq ft)
LIVABLE VOLUME	906 + 241 L (32 + 8.5 cu ft)
INTERIOR PEAK HEIGHT	1.04 m (41 in)
POLES	1 Easton Syclone
FABRICS	
RAINFLY	20D ripstop nylon 1200 mm XtremeShield™ polyurethane & silicone
CANOPY	20D ripstop nylon / 10D polyester micromesh
FLOOR	30D ripstop nylon 3000 mm XtremeShield™ polyurethane & DWR
SKU	
ACCESS 1	13116
FOOTPRINT	13009
MADE IN	IMPORTED



Access™ 2

A winter backpacking tent with two doors for easy access.

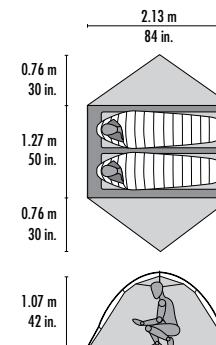

Access™ 2	
CAPACITY	2
MIN. WEIGHT	1.64 kg (3 lb 10 oz)
FLOOR + VESTIBULE	2.69 + 1.62 sq m (29 + 17.5 sq ft)
LIVABLE VOLUME	1586 + 481 L (56 + 17 cu ft)
INTERIOR PEAK HEIGHT	1.07 m (42 in)
POLES	1 Easton Syclone
FABRICS	
RAINFLY	20D ripstop nylon 1200 mm XtremeShield™ polyurethane & silicone
CANOPY	20D ripstop nylon / 10D polyester micromesh
FLOOR	30D ripstop nylon 3000 mm XtremeShield™ polyurethane & DWR
SKU	
ACCESS 2	13117
FOOTPRINT	13010
MADE IN	IMPORTED

Access™ 3

Featuring extra space for three, so no one is left out in the cold.

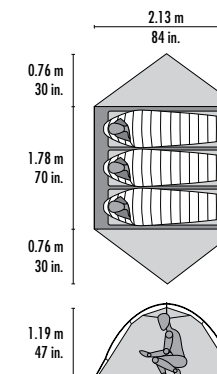

Access™ 3	
CAPACITY	3
MIN. WEIGHT	1.99 kg (4 lb 6 oz)
FLOOR + VESTIBULE	3.8 + 1.62 sq m (41 + 17.5 sq ft)
LIVABLE VOLUME	2576 + 538 L (91 + 19 cu ft)
INTERIOR PEAK HEIGHT	1.19 m (47 in)
POLES	1 Easton Syclone
FABRICS	
RAINFLY	20D ripstop nylon 1200 mm XtremeShield™ polyurethane & silicone
CANOPY	20D ripstop nylon / 10D polyester micromesh
FLOOR	30D ripstop nylon 3000 mm XtremeShield™ polyurethane & DWR
SKU	
ACCESS 3	13118
FOOTPRINT	13013
MADE IN	IMPORTED

ALL-SEASON TENTS

REMOTE™ SERIES

Our Remote mountaineering tents are more livable and weather-resistant than other mountaineering tents on the market. Whether you're spending 3 days or several weeks on the mountain, these expedition-grade, guide-worthy tents deliver the protection you need and the livability you want.

DURABLE PROTECTION

The tents' virtually indestructible Easton® Syclone™ poles* are made strong and flexible to resist breaking in severe conditions.

PROVEN DESIGN

The unique central support frame stands up to extremely high winds and resists snow loading.

LIVABILITY

Added space, two large doors, and a large hooped vestibule accommodate climbers with bulky winter gear. Gear loops and other livable features add comfort for weeks in harsh conditions.

* Easton® and Syclone™ trademarks are owned by Easton® Technical Products.



Remote™ 2

Extreme protection multiday mountaineering tent for two.

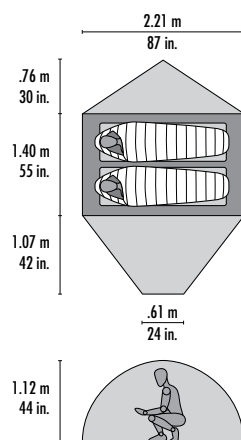

Remote™ 2	
CAPACITY	2
MIN. WEIGHT	3.02 kg (6 lb 11 oz)
FLOOR + VESTIBULE	3.06 + 2.04 sq m (33 + 22 sq ft)
LIVABLE VOLUME	2108 + 1104 L (77 + 39 cu ft)
INTERIOR PEAK HEIGHT	1.12 m (44 in)
POLES	3 Easton Syclone
FABRICS	
RAINFLY	68D ripstop polyester 1500 mm polyurethane & DWR
CANOPY	40D ripstop nylon DWR / 15D polyester micromesh
FLOOR	40D ripstop nylon 10,000 mm DuraShield™ polyurethane & DWR
SKU	
REMOTE 2	13113
FOOTPRINT	13011
MADE IN	IMPORTED

Remote™ 3

Extra width and length adds room for three mountaineers and their gear.

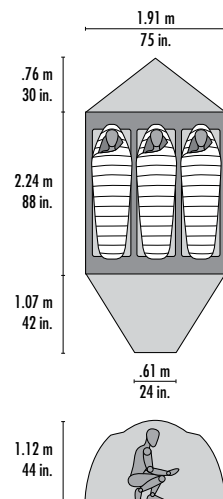

Remote™ 3	
CAPACITY	3
MIN. WEIGHT	3.69 kg (8 lb 2 oz)
FLOOR + VESTIBULE	4.30 + 2.04 sq m (46 + 22 sq ft)
LIVABLE VOLUME	3171 + 1161 L (112 + 41 cu ft)
INTERIOR PEAK HEIGHT	1.12 m (44 in)
POLES	4 Easton Syclone
FABRICS	
RAINFLY	68D ripstop polyester 1500 mm polyurethane & DWR
CANOPY	40D ripstop nylon DWR / 15D polyester micromesh
FLOOR	40D ripstop nylon 10,000 mm DuraShield™ polyurethane & DWR
SKU	
REMOTE 3	13114
FOOTPRINT	13013
MADE IN	IMPORTED



Front Range™ Ultralight Tarp Shelter

So compact and light, it's hardly noticeable in your pack, the Front Range tarp shelter protects parties of four on giant alpine missions, like spring ski traverses. Supremely versatile—use it as a dining hall—this pack-small, ultra-simple shelter is boosted with our Xtreme Shield™ coating to outlast the competition.

- **Ultralight & Spacious:** Comfortably sleeps four with a 5' 4" peak height for gearing up, at just .74 kg (1 lb 10 oz).
- **Quick Setup:** Floorless tarp sets up quickly with ski or trekking poles; ski straps included for easy assembly.
- **Easy Access:** Zippered door rolls back completely on both sides for sweeping views and easy entry.
- **Versatile:** Light enough to carry as a solo shelter, dining hall, or emergency shelter. Optional Bug/Floor Insert available for wet & buggy terrain.
- **Durable:** Steep canopy sheds snow and water and features Xtreme Shield waterproof coating for long-term durability.
- Accessory pole sold separately.

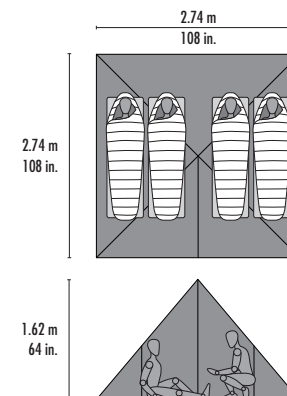

Front Range™ Ultralight Tarp Shelter	
CAPACITY	4
MIN. WEIGHT	.74 kg (1 lb 10 oz)
FLOOR	7.52 sq m (81 sq ft)
LIVABLE VOLUME	4078 L (144 cu ft)
INTERIOR PEAK HEIGHT	1.62 m (64 in)
FABRICS	
RAINFLY	20D ripstop nylon 1200mm Xtreme Shield™ polyurethane & silicone
CANOPY	
FLOOR	
SKU	
FRONT RANGE ULTRALIGHT TARP SHELTER	13119
FOOTPRINT	13135
MADE IN	IMPORTED

ALL-SEASON TENTS



Front Range™ Bug/Floor Insert

Turns your Front Range tarp into a full-protection shelter in wet & buggy terrain.

- Micromesh canopy with durable bathtub floor
- Zippered door
- Sets up easily with ski or trekking poles; ski straps included for easy assembly
- Peak cone keeps fly off mesh
- Accessory pole sold separately.

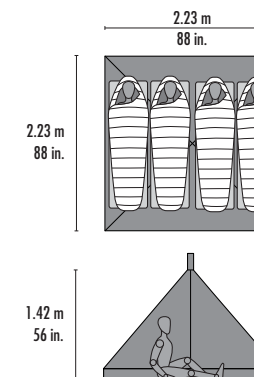

Front Range™ Bug/Floor Insert	
CAPACITY	4
MIN. WEIGHT	.88 kg (1 lb 15 oz)
FLOOR	4.97 sq m (53.5 sq ft)
LIVABLE VOLUME	2350 L (83 cu ft)
INTERIOR PEAK HEIGHT	1.42 m (56 in)
FABRICS	
RAINFLY	15D nylon micro-mesh
CANOPY	30D ripstop nylon 3000mm Xtreme Shield™ polyurethane & DWR
FLOOR	
SKU	
FRONT RANGE BUG/FLOOR INSERT	13120
FOOTPRINT	13135
MADE IN	IMPORTED

PROFESSIONAL SERIES

Designed with direct input from professionals in the field, our Pro Series tents are engineered to meet the needs of professional athletes, guides and outfitters. When the success of the expedition, or the safety of the client requires durable, purpose-engineered gear, these tents deliver.



PHOTO: SCOTT RINCKENBERGER

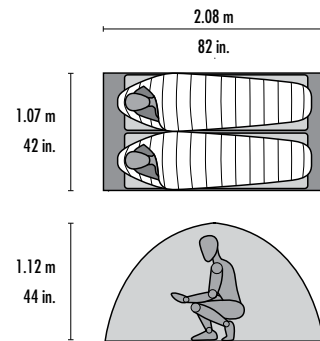

Advance Pro™ 2

The ultimate tent for professional alpinists.

- Rainfly vents reduce condensation
- Supports first ascents and summit approaches
- Easton® Syclone™ Poles resist breaking in severe winds
- Small footprint for pitching on a ledge
- Hybrid clip pole-sleeve sets up in seconds by one person

Advance Pro™ 2	
CAPACITY	2
MIN. WEIGHT	1.30 kg (2 lb 14 oz)
FLOOR + VESTIBULE	2.23 sq m (24 sq ft)
LIVABLE VOLUME	1076 L (38 cu ft)
INTERIOR PEAK HEIGHT	1.12 m (44 in)
POLES	1 Easton Syclone
FABRICS	
RAINFLY	20D ripstop nylon 2 ply breathable 1000 mm
FLOOR	30D ripstop nylon 3000 mm XtremeShield™ polyurethane & DWR
SKU	
ADVANCE PRO™ 2	13110
FOOTPRINT	13019
MADE IN	IMPORTED

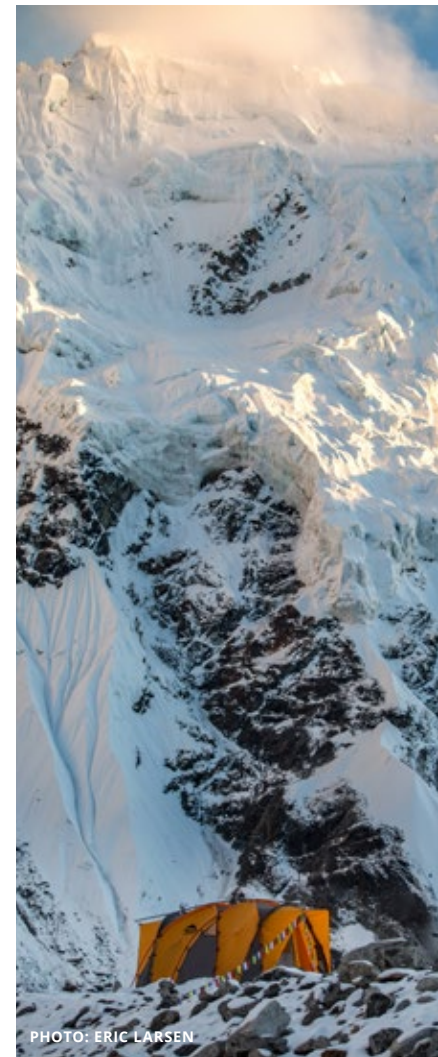

PHOTO: ERIC LARSEN



Pro™ Bivy

The ultimate bivy for professional alpinists.

- Ultralight bivy for pro alpinists and fast & light missions
- Quick-pitch waterproof protection in cramped spaces too small for a tent
- Breathable fabric helps reduce condensation

Pro Bivy	
CAPACITY	1
MIN. WEIGHT	.28 kg (10 oz)
FABRICS	
RAINFLY	20D ripstop nylon 2 ply breathable 1000 mm
FLOOR	15D ripstop nylon 1200mm Xtreme Shield™ polyurethane & DWR
SKU	
PRO BIVY	10830
MADE IN	IMPORTED



H.U.B.™

High-Altitude Utility Basecamp tent for professional alpinists.

- UPF 50+ coating inside for greater sun protection on expeditions
 - Airline-manageable 49-lb packaged weight
 - Two entrances with large door, second mesh door and large closable window
 - Removable door panels allow for flexible ventilation and protection
 - Clear windows for checking on the weather
 - Large pockets for storing bulky jackets
- Intended for professional use.
Does not include: stakes, guy line, setup instructions.

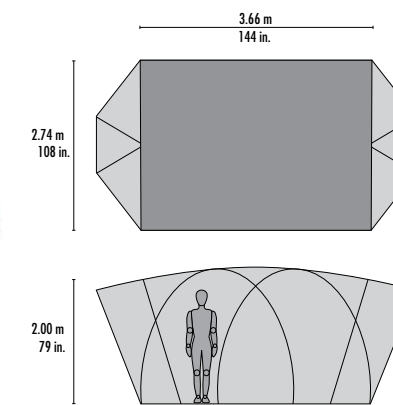

H.U.B.™	
CAPACITY	8 + Gear
MIN. WEIGHT	21.77 kg (48 lb)
FLOOR + VESTIBULE	10.03 sq m (108 sq ft)
LIVABLE VOLUME	17273 L (610 cu ft)
INTERIOR PEAK HEIGHT	2 m (79 in)
POLES	7 6000 Series Aluminum
FABRICS	
RAINFLY	150D ripstop polyester 1500 mm polyurethane & DWR
FLOOR	68 taffeta polyester 10,000 mm polyurethane & DWR
SKU	
H.U.B.™	13111
MADE IN	IMPORTED

ALL-SEASON TENTS



H.U.B.™ Gear Shed

Increases the storage space of the H.U.B. tent.

- Attaches to H.U.B. to provide extra space (protected storage or sleeping area)
- Floor creates a clean place to store gear
- Frees up tent space for summit and expedition preparations
- 65 additional square feet for less than 10 lbs

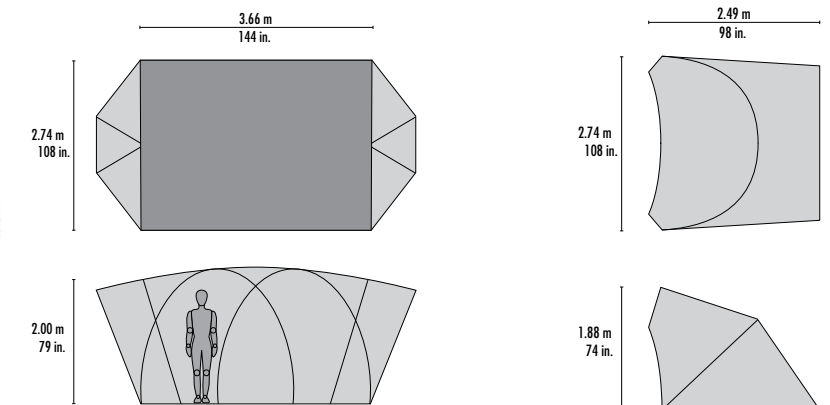

H.U.B.™ Gear Shed	
CAPACITY	4 + Gear
MIN. WEIGHT	4.18 kg (9 lb 3 oz)
FLOOR + VESTIBULE	6.4 sq m (69 sq ft)
LIVABLE VOLUME	6937 L (245 cu ft)
INTERIOR PEAK HEIGHT	1.88 m (74 in)
POLES	1 7000 Series Aluminum
FABRICS	
RAINFLY	150D ripstop polyester 1500 mm polyurethane & DWR
FLOOR	68 taffeta polyester 10,000 mm polyurethane & DWR
SKU	
H.U.B.™ GEAR SHED	09540
MADE IN	IMPORTED

RENDEZVOUS™ SERIES

With a UPF of 50+, Rendezvous shelters provide excellent sun, wind and rain protection at campsites and gathering areas.

PROTECTED COVERAGE

A UPF of 50+ for excellent UV protection, the Rendezvous™ 120 & 200 Wings create nearly 120 square feet and 200 square feet of protected coverage at camp.

STABLE

The shelters' unique 7-point design pitches taut and remains stable in high winds.

VERSATILE

Shelter height can be increased with the use of additional accessory poles.

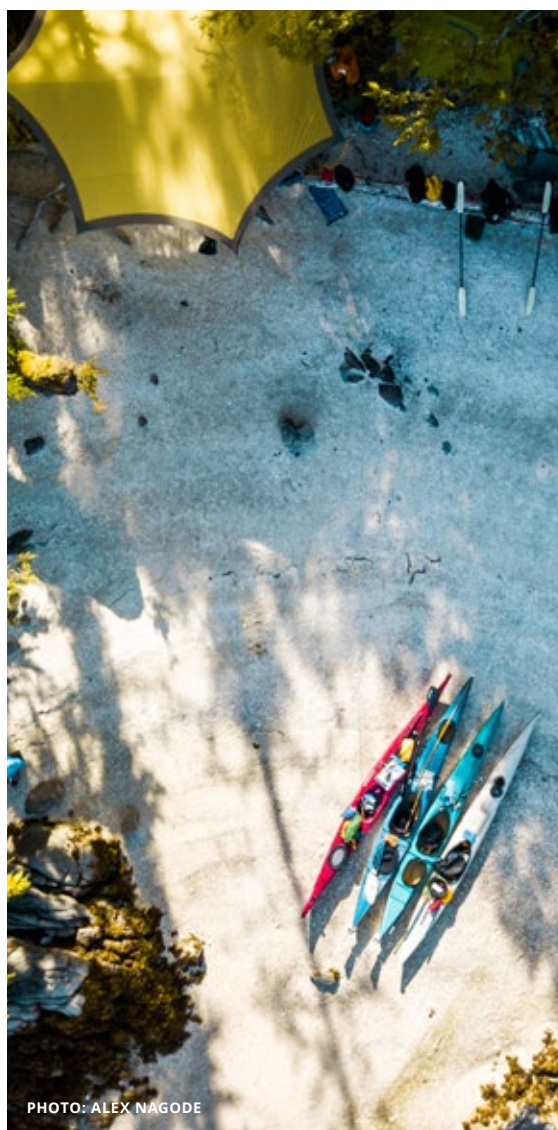

PHOTO: ALEX NAGODE



E-Bivy™

Emergency shelter for backcountry adventures.

- Ultralight, ultra-packable emergency shelter
- Durable bivy offers warmth & weather-resistant protection
- Silicone coated fabric top, Xtreme Shield™ waterproof floor

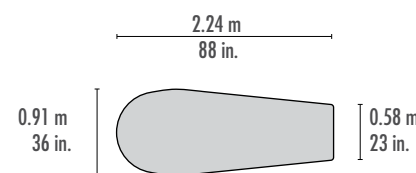

E-Bivy™	
CAPACITY	1
MIN. WEIGHT	.18 kg (6 oz)
FABRICS	
TOP	15D ripstop nylon silicone coated
FLOOR	15D ripstop nylon 1200mm Xtreme Shield™ polyurethane & DWR
SKU	
E-BIVY	10852
MADE IN	IMPORTED

MINIMALIST TENTS



Rendezvous™ Sun Shield 120 Wing

Lightweight shelter offers coverage for 1-4 people, with the option to go even lighter using trees as poles.

Rendezvous™ Sun Shield 200 Wing

Ideal sun, rain and wind protection for up to a dozen people.

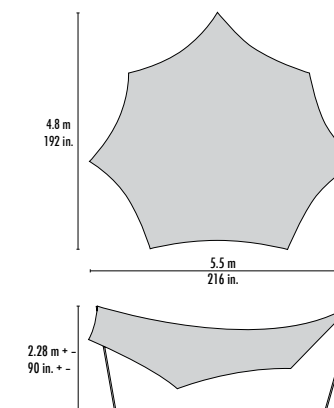
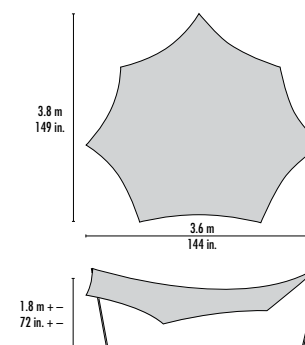

Rendezvous™ Sun Shield 120 Wing	
CAPACITY	2-4
MIN. WEIGHT	1.47 kg (3 lb 14 oz)
MIN. WEIGHT (NO POLES)	.82 kg (1 lb 13 oz)
COVERAGE	10 sq m (120 sq ft)
INTERIOR PEAK HEIGHT	VARIABLE
POLES	2 6000 Series Aluminum
FABRICS	
RAINFLY	68D ripstop polyester 1500mm polyurethane & DWR
SKU	
RENDEZVOUS 120 WING	10825
MADE IN	IMPORTED

Rendezvous™ Sun Shield 200 Wing	
CAPACITY	6-12
MIN. WEIGHT	2.77 kg (6 lb)
MIN. WEIGHT (NO POLES)	1.51 kg (3 lb 5 oz)
COVERAGE	18.6 sq m (200 sq ft)
INTERIOR PEAK HEIGHT	VARIABLE
POLES	2 6000 Series Aluminum
FABRICS	
RAINFLY	68D ripstop polyester 1500mm polyurethane & DWR
SKU	
RENDEZVOUS 200 WING	10826
MADE IN	IMPORTED

MINIMALIST SHELTERS & WINGS

Ultralight and compact shelters designed for gram-counting backpackers, minimalists and thru-hikers.

MINIMALIST TENTS



Thru-Hiker 70 Wing

Wind and rain protection for 1-3 people that packs up tiny in small backpacks. Compatible with Thru-Hiker Mesh House 1, 2 or 3.

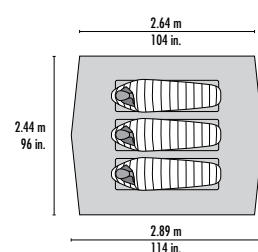

Thru-Hiker 100 Wing

Comfortably offers 3 people ample protection with minimal impact on total pack weight. Compatible with Thru-Hiker Mesh House 1, 2 or 3.

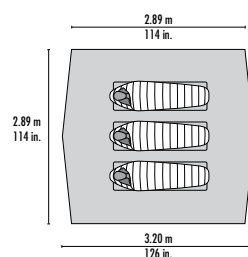

Thru-Hiker Mesh House 1

MSR's long-distance backpacking shelter for soloists. Compatible with Thru-Hiker 70 Wing or 100 Wing.

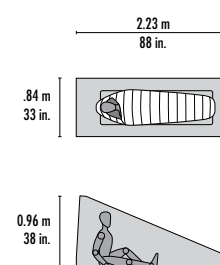

Thru-Hiker Mesh House 2

Ultimate 2-person shelter for long-distance backpacking trips. Compatible with Thru-Hiker 70 Wing or 100 Wing.

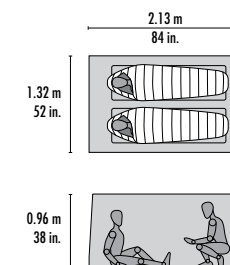

Thru-Hiker Mesh House 3

Ultralight shelter with extra room for three without much added weight. Compatible with Thru-Hiker 70 Wing or 100 Wing.

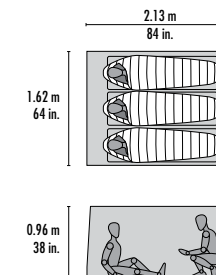

Thru-Hiker 70 Wing	
CAPACITY	2-3
MIN. WEIGHT	.38 kg (12 oz)
COVERAGE	6.50 sq m (70 sq ft)
DIMENSIONS	2.89 x 2.43 m (9 ft 6 in x 8 ft)
INTERIOR PEAK HEIGHT	Variable
FABRICS	
RAINFLY	20D ripstop nylon Xtreme Shield™ coated 1200 mm & silicone
SKU	
THRU-HIKER WING	10827
MADE IN	IMPORTED

Thru-Hiker 100 Wing	
CAPACITY	2-3
MIN. WEIGHT	.49 kg (1 lb 1 oz)
COVERAGE	9.29 sq m (100 sq ft)
DIMENSIONS	3.2 x 2.89 m (10 ft 6 in x 9 ft 6 in)
INTERIOR PEAK HEIGHT	Variable
FABRICS	
RAINFLY	20D ripstop nylon Xtreme Shield™ coated 1200 mm & silicone
SKU	
THRU-HIKER WING	10828
MADE IN	IMPORTED

Thru-Hiker Mesh House 1	
CAPACITY	1
MIN. WEIGHT	.28 kg (10 oz)
FLOOR + VESTIBULE	1.86 sq m (20 sq ft)
LIVABLE VOLUME	651 L (23 cu ft)
INTERIOR PEAK HEIGHT	.96 m (38 in)
FABRICS	
CANOPY	10D polyester micromesh
FLOOR	15D ripstop nylon Xtreme Shield™ 1200 mm & silicone
SKU	
THRU-HIKER MESH HOUSE 1	10822
FOOTPRINT	13009
MADE IN	IMPORTED

Thru-Hiker Mesh House 2	
CAPACITY	2
MIN. WEIGHT	.41 kg (14 oz)
FLOOR + VESTIBULE	2.78 sq m (30 sq ft)
LIVABLE VOLUME	1642 L (58 cu ft)
INTERIOR PEAK HEIGHT	.96 m (38 in)
FABRICS	
CANOPY	10D polyester micromesh
FLOOR	15D ripstop nylon Xtreme Shield™ 1200 mm & silicone
SKU	
THRU-HIKER MESH HOUSE 2	10823
FOOTPRINT	13010
MADE IN	IMPORTED

Thru-Hiker Mesh House 3	
CAPACITY	3
MIN. WEIGHT	.46 kg (1 lb)
FLOOR + VESTIBULE	3.43 sq m (37 sq ft)
LIVABLE VOLUME	2024 L (71.5 cu ft)
INTERIOR PEAK HEIGHT	.96 m (38 in)
FABRICS	
CANOPY	10D polyester micromesh
FLOOR	15D ripstop nylon Xtreme Shield™ 1200 mm & silicone
SKU	
THRU-HIKER MESH HOUSE 3	10824
FOOTPRINT	13012
MADE IN	IMPORTED



PHOTO: SCOTT RINCKENBERGER



Carbon-Core™ Tent Stakes

- Our lightest full-strength, hard-ground tent stakes
- Carbon fiber core with aluminum outer
- Extremely durable head and aluminum tip
- 5.75 g (.2 oz), 15 cm (6 in)

Kit (4 Stakes)

SKU	02499
MADE IN	USA OF U.S. AND IMPORTED MATERIALS



Core™ Stakes

- Ultralight high-strength stakes for hard ground
- 7075 aluminum with solid aluminum head
- 14 g (.5 oz), 23 cm (9 in)

9" Kit (4 Stakes)

SKU	09563
MADE IN	USA OF U.S. AND IMPORTED MATERIALS



MSR® Stake Hammer

- Hardened stainless steel head
- Perfectly balanced for driving tent stakes
- Comfortable shaft
- Essential bottle opener
- 312 g (11 oz)

MSR® Stake Hammer

SKU	03074
MADE IN	TAIWAN



Adjustable Poles

- Ideal for tarp and wing shelters
- Aircraft-grade aluminum
- 2.4 m (8 ft) pole adjusts from 208-259 cm (82-102 in)
- 1.5 m (5 ft) pole adjusts from 140-167 cm (55-66 in)
- 1.2 m (4 ft) pole adjusts from 119-140 cm (47-55 in)

1.2 M 1.5 M 2.4 M

SKU	05828	13311	05830
MADE IN	KOREA		



Tent Pole Repair Splint

- 13 mm (.51 in) fits most 1-3 person tents
- 16 mm (.63 in) fits most 2-4 person tents
- Easily applied splint for field repairs

13mm (.51 in) 16mm (.63 in)

SKU	05826	05827
MADE IN	KOREA	



Mini-Groundhog™ Tent Stakes

- Lighter version of Groundhog stake
- 7075-series aluminum
- Pull cord
- 10 g (.35 oz), 15 cm (6 in)

Kit (6 stakes) Bulk

SKU	05808	06621
MADE IN	KOREA	



Groundhog™ Tent Stakes

- Tri-beam design
- 7075-series aluminum
- 13 g (.46 oz), 19 cm (7.5 in)

Kit (6 stakes) Bulk

SKU	05807	05885
MADE IN	KOREA	



CamRing™ Cord Tensioners

- Ring design locks securely
- Ultralight and easy to adjust
- Large rings fit 3 to 5 mm cord

Large (2 Rings)

SKU	05817
MADE IN	KOREA



Tent Guy Lines

- Lightweight and adjustable
- Secure, non-slip design
- (4) Medium 2.4 m (8 ft) guy lines with CamRing™ Cord Tensioners

Medium (4)

SKU	05820
MADE IN	KOREA



Reflective Utility Cord Kit

- 15 m (49.2 ft) of highly reflective 3 mm cord
- 4 CamRing Cord Tensioners

Reflective Utility Cord Kit

SKU	05818
MADE IN	KOREA



Cyclone™ Tent Stakes

- Holds in soft ground
- Ideal for large tarps and wings
- 35 g (1.2 oz), 25 cm (10 in)

Kit (4 stakes)

SKU	05806
MADE IN	KOREA



Blizzard Tent Stakes

- Broad profile holds well in sand/snow
- 7075-series aluminum
- Can be used as deadman anchor
- 21 g (.74 oz), 24 cm (9.5 in)

Kit (4 stakes) Bulk

SKU	05809	05810
MADE IN	KOREA	



Ultralight Cord- 10 m (32 ft)

- 10 m (32 ft) of highly reflective 2.5 mm cord
- 200 lb high tensile strength cord

Ultralight Cord

SKU	05819
MADE IN	KOREA



Shock Cord Replacement Kit

- Silicone core remains elastic to -20°F / -30°C
- 9.1 m (30 ft) cord
- Instructions included

Shock Cord Replacement Kit

SKU	05834
MADE IN	KOREA



Universal Zipper Pulls/ Night Glow Zipper Pulls

- Glow-in-the-dark, glows for up to 8 hours
- Easy to use with gloves
- Reflective and lightweight
- Quieter than metal pulls
- Easy to use with gloves

Night Glow (2 Pulls) Universal (4 Pulls)

SKU	05833	05832
MADE IN	CHINA	

**MSR® SHELTER SPECIFICATIONS & COMPARISON**

CAMPING TENTS	SKU	CAP.	DOORS	MIN WEIGHT	PACKAGED WEIGHT	FLOOR + VESTIBULE	LIVABLE VOLUME TENT + VESTIBULE	INTERIOR PEAK HEIGHT	PACKED SIZE
Habitude™ 4	13128	4	1	5.44kg (12 lb)	5.72 kg (12 lb 10 oz)	5.80 + .218 sq m (62.4 + 23.5 sq ft)		1.85 m (73 in)	58 x 23 cm (23 x 9 in)
Habitude™ 6	13129	6	1	6.08 kg (13 lb 6 oz)	6.35 kg (14 lb)	7.71 + 2.27 sq m (83 + 24.5 sq ft)		1.95 m (77 in)	58 x 25 cm (23 x 10 in)
BACKPACKING TENTS	SKU	CAP.	DOORS	MIN WEIGHT	PACKAGED WEIGHT	FLOOR + VESTIBULE	LIVABLE VOLUME TENT + VESTIBULE	INTERIOR PEAK HEIGHT	PACKED SIZE
Elixir™ 1	10310	1	1	1.78 kg (3 lb 15 oz)	2.16 kg (4 lb 12 oz)	1.86 + 1.11 sq m (20 + 12 sq ft)	793 + 340 L (28 + 12 cu ft)	1 m (39 in)	48 x 15 cm (19 x 6 in)
Elixir™ 2	10311	2	2	2.24 kg (5 lb)	2.77 kg (6 lb)	2.69 + 2.22 sq m (29 + 24 sq ft)	1274 + 708 L (45 + 25 cu ft)	1.02 m (40 in)	51 x 17 cm (20 x 7 in)
Elixir™ 3	10312	3	2	2.66 kg (5 lb 14 oz)	3.19 kg (7 lb)	3.67 + 2.22 sq m (39.5 + 24 sq ft)	1784 + 708 L (63 + 25 cu ft)	1.04 m (41 in)	51 x 20 cm (20 x 8 in)
Elixir™ 4	10313	4	2	3.6 kg (7 lb 15 oz)	4.26 kg (9 lb 6 oz)	5.02 + 2.27 sq m (54 + 24.5 sq ft)	3285 + 850 L (116 + 30 cu ft)	1.21 m (48 in)	56 x 17 cm (22 x 7 in)
Zoic™ 1	10892	1	1	1.5 kg (3 lb 5 oz)	1.71 kg (3 lb 12 oz)	1.99 + .84 sq m (21.5 + 9 sq ft)	963 + 270 L (34 + 9.5 cu ft)	1 m (39 in)	51 x 13 cm (20 x 5 in)
Zoic™ 2	10893	2	2	1.97 kg (4 lb 6 oz)	2.19 kg (4 lb 13 oz)	3.07 + 1.67 sq m (33 + 18 sq ft)	1529 + 539 L (54 + 19 cu ft)	1 m (39 in)	53 x 13 cm (21 x 5 in)
Zoic™ 3	10894	3	2	2.45 kg (5 lb 7 oz)	2.67 kg (5 lb 14 oz)	4.27 + 1.67 sq m (46 + 18 sq ft)	2888 + 539 L (102 + 19 cu ft)	1.09 m (43 in)	53 x 13 cm (21 x 5 in)
Zoic™ 4	13126	4	2	3.06 kg (6 lb 12 oz)	3.28 kg (7 lb 4 oz)	5.20 + 1.71 sq m (56 + 18.5 sq ft)	4585 + 522 L (162 + 19.5 cu ft)	1.27 m (50 in)	56 x 15 cm (22 x 6 in)
Gear Shed	10314	GEAR		.82 kg (1 lb 13 oz)	.94 kg (2 lb 1 oz)	2.46 sq m (26.5 sq ft)	651 L (23 cu ft)	.89 m (35 in)	48 x 11 cm (19 x 4.5 in)
Hubba™ NX	10315	1	1	1.12 kg (2 lb 7 oz)	1.29 kg (2 lb 14 oz)	1.67 + .84 sq m (18 + 9 sq ft)	736 + 241 L (26 + 8.5 cu ft)	.91 m (36 in)	46 x 15 cm (18 x 6 in)
Hubba Hubba™ NX	10316	2	2	1.60 kg (3 lb 8 oz)	1.76 kg (3 lb 14 oz)	2.7 + 1.62 sq m (29 + 17.5 sq ft)	1217 + 481 L (43 + 17 cu ft)	1 m (39 in)	46 x 15 cm (18 x 6 in)
Mutha Hubba™ NX	10317	3	2	1.95 kg (4 lb 5 oz)	2.18 kg (4 lb 13 oz)	3.67 + 1.30 sq m (39 + 14 sq ft)	2290 + 453 L (81 + 16 cu ft)	1.12 m (44 in)	53 x 17 cm (21 x 7 in)
FreeLite™ 1	10325	1	1	0.9 kg (2 lb)	1.13 kg (2 lb 8 oz)	1.67 + .83 sq m (18 + 9 sq ft)	651 + 198 L (23 + 7 cu ft)	.91 m (36 in)	46 x 15 cm (18 x 6 in)
FreeLite™ 2	10326	2	2	1.14 kg (2 lb 8 oz)	1.33 kg (2 lb 15 oz)	2.70 + 1.62 sq m (29 + 17.5 sq ft)	850 + 410 L (30 + 14.5 cu ft)	.91 m (36 in)	46 x 15 cm (18 x 6 in)
FreeLite™ 3	10327	3	2	1.34 kg (2 lb 15 oz)	1.56 kg (3 lb 7 oz)	3.67 + 1.62 sq m (39.5 + 17.5 sq ft)	1330 + 410 L (47 + 14.5 cu ft)	1 m (39 in)	46 x 15 cm (18 x 6 in)
Carbon Reflex™ 1	10322	1	1	.66 kg (1 lb 7 oz)	.79 kg (1 lb 13 oz)	1.63 + .65 sq m (17 + 7 sq ft)	651 + 190 L (23 + 7 cu ft)	.86 m (34 in)	43 x 13 cm (17 x 5 in)
Carbon Reflex™ 2	10323	2	2	.84 kg (1 lb 13 oz)	.99 kg (2 lb 3 oz)	2.69 + 1.30 sq m (29 + 14 sq ft)	1217 + 382 L (43 + 13.5 cu ft)	.86 m (34 in)	43 x 13 cm (17 x 5 in)
Carbon Reflex™ 3	10324	3	2	1.03 kg (2 lb 4 oz)	1.19 kg (2 lb 10 oz)	3.58 + 1.30 sq m (38.5 + 14 sq ft)	1444 + 425 L (51 + 15 cu ft)	1.01 m (40 in)	46 x 15 cm (18 x 6 in)

**MSR® SHELTER SPECIFICATIONS & COMPARISON**

MINIMALIST SHELTERS	SKU	CAP.	DOORS	MIN WEIGHT	PACKAGED WEIGHT	FLOOR + VESTIBULE	LIVABLE VOLUME TENT + VESTIBULE	INTERIOR PEAK HEIGHT	PACKED SIZE
E-Bivy™	10852	1		.18 kg (6 oz)	.20 kg (7 oz)				18 x 10 cm (7 x 4 in)
Rendezvous™ Sun Shield Wing 120	10825	2-4		1.47 kg (3 lb 4 oz)	1.62 kg (3 lb 9 oz)	10 sq m (120 sq ft)		Variable	51 x 15 cm (20 x 6 in)
Rendezvous™ Sun Shield Wing 200	10826	6-12		2.77 kg (6 lb)	3.06 kg (6 lb 10 oz)	18.60 sq m (200 sq ft)		Variable	63.5 x 15 cm (25 x 6 in)
Thru-Hiker 70 Wing	10827	2-3		.38 kg (12 oz)	.46 kg (1 lb)	6.50 sq m (70 sq ft)		Variable	23 x 10 cm (9 x 4 in)
Thru-Hiker 100 Wing	10828	2-3		.49 kg (1 lb 1 oz)	.57 kg (1 lb 4 oz)	9.29 sq m (100 sq ft)		Variable	23 x 10 cm (9 x 4 in)
Thru-Hiker Mesh House 1	10822	1	1	.28 kg (10 oz)	.41 kg (14 oz)	1.86 sq m (20 sq ft)	651 L (23 cu ft)	.96 m (38 in)	20 x 10 cm (8 x 4 in)
Thru-Hiker Mesh House 2	10823	2	1	.41 kg (14 oz)	.48 kg (1 lb 2 oz)	2.78 sq m (30 sq ft)	1642 L (58 cu ft)	.96 m (38 in)	25 x 10 cm (10 x 4 in)
Thru-Hiker Mesh House 3	10824	3	1	.46 kg (1 lb)	.57 kg (1 lb 4 oz)	3.43 sq m (37 sq ft)	2024 L (71.5 cu ft)	.96 m (38 in)	25 x 10 cm (10 x 4 in)
ALL-SEASON TENTS	SKU	CAP.	DOORS	MIN WEIGHT	PACKAGED WEIGHT	FLOOR + VESTIBULE	LIVABLE VOLUME TENT + VESTIBULE	INTERIOR PEAK HEIGHT	PACKED SIZE
Front Range™ Ultralight Tarp Shelter	13119	4	1	.74 kg (1 lb 10 oz)	.91 kg (2 lb)	7.52 sq m (81 sq ft)	4078 L (144 cu ft)	1.62 m (64 in)	30 x 13 cm (12 x 5 in)
Front Range™ Bug/Floor Insert	13120	4	1	.88 kg (1 lb 15 oz)	1.04 kg (2 lb 5 oz)	4.97 sq m (53.5 sq ft)	2350 L (83 cu ft)	1.42 m (56 in)	30 x 13 cm (12 x 5 in)
Access™ 1	13116	1	1	1.37 kg (3 lb)	1.60 kg (3 lb 8 oz)	1.76 + .23 sq m (19 + 9 sq ft)	906 + 241 L (32 + 8.5 cu ft)	1.01 m (40 in)	46 x 15 cm (18 x 6 in)
Access™ 2	13117	2	2	1.64 kg (3 lb 10 oz)	1.86 kg (4 lb 1 oz)	2.69 + 1.62 sq m (29 + 17.5 sq ft)	1586 + 481 L (56 + 17 cu ft)	1.07 m (42 in)	46 x 15 cm (18 x 6 in)
Access™ 3	13118	3	2	1.99 kg (4 lb 6 oz)	2.3 kg (5 lb 1 oz)	3.8 + 1.62 sq m (41 + 17.5 sq ft)	2756 + 538 L (91 + 19 cu ft)	1.19 m (47 in)	53 x 17 cm (21 x 7 in)
Remote™ 2	13113	2	2	3.02 kg (6 lb 11 oz)	3.23 kg (7 lb 2 oz)	3.06 + 2.04 sq m (33 + 22 sq ft)	2108 + 1104 L (77 + 39 cu ft)	1.12 m (44 in)	51 x 17 cm (20 x 7 in)
Remote™ 3	13114	3	2	3.69 kg (8 lb 2 oz)	3.99 kg (8 lb 13 oz)	4.3 + 2.04 sq m (46 + 22 sq ft)	3171 + 1161 L (112 + 41 cu ft)	1.12 m (44 in)	51 x 20 cm (20 x 8 in)
PROFESSIONAL SERIES	SKU	CAP.	DOORS	MIN WEIGHT	PACKAGED WEIGHT	FLOOR + VESTIBULE	LIVABLE VOLUME TENT + VESTIBULE	INTERIOR PEAK HEIGHT	PACKED SIZE
Pro Bivy	10830	1		.28 kg (10 oz)	.34 kg (12 oz)				20 x 10 cm (8 x 4 in)
Advance Pro™ 2	13110	2	1	1.30 kg (2 lb 14 oz)	1.46 kg (3 lb 3 oz)	2.23 sq m (24 sq ft)	1076 L (38 cu ft)	1.12 m (44 in)	46 x 15 cm (18 x 6 in)
H.U.B.™	13111	8 + GEAR	2	21.77 kg (48 lb)	22.22 kg (49 lb)	10.03 sq m (108 sq ft)	17273 L (610 cu ft)	2 m (79 in)	76 x 46 cm (30 x 18 in)
H.U.B.™ Gear Shed	09540	4 + GEAR	2	4.18 kg (9 lb 3 oz)	4.40 kg (9 lb 11 oz)	6.4 sq m (69 sq ft)	6937 L (245 cu ft)	1.88 m (74 in)	61 x 23 cm (24 x 9 in)

**QUALITY
BRED FROM
SIMPLICITY**

PHOTO: SCOTT RINCKENBERGER

2021 LINE PLAN | SNOWSHOES

LIGHTNING™ ASCENT
(Men's & Women's)

REVO™ ASCENT
(Men's & Women's)

EVO™ ASCENT

\$\$\$ \$\$\$ \$ \$

LIGHTNING™ EXPLORE
(Men's & Women's)

REVO™ EXPLORE
(Men's & Women's)

LIGHTNING™ TRAIL
(Men's & Women's)

REVO™ TRAIL
(Men's & Women's)

EVO™ TRAIL

ASCENT

EXPLORE

TRAIL



BACKCOUNTRY POLES

For snowshoeing, winter travel, and backcountry adventures.

DynaLock™ Secure Adjustment:

For easy, rock-solid performance and tool-free tensioning.

Comfortable: Light, ergonomic grips.

Premium Materials: Light, strong construction. Anodized aluminum lever on DynaLock for lasting durability.



DynaLock™ Ascent Carbon

Folding Carbon Pole

- **Ultralight:** Ideal for fast-and-light snowshoeing, mountaineering, splitboarding.
- Kevlar®-reinforced carbon fiber
- Quick-deploy, folding design
- EVA foam grip, plus lower sidehilling grip
- Trekking baskets included

SIZE	SMALL 100-120 CM	LARGE 120-140CM
WEIGHT	471 g (17 oz)	496 g (18 oz)
SKU	10236	10237
MADE IN	TAIWAN	

DynaLock™ Explore

3-Section Aluminum Poles

- **Compact:** Excellent versatility for local and distant snowshoeing and mountaineering trips.
- Light, high-strength 7075 aluminum lowers
- Extended EVA foam grip
- Trekking baskets included

63-140 CM	
WEIGHT	552 g (19 oz)
SKU	10238
MADE IN	TAIWAN

DynaLock™ Trail

2-Section Aluminum Poles

- **Strong:** The simple and durable choice for casual snowshoers and winter hikers.
- Light, two-piece design
- Ergonomic grip and adjustable strap
- Trekking baskets included

81-140 CM	
WEIGHT	592 g (21 oz)
SKU	10239
MADE IN	TAIWAN



SNOWSHOE KITS

High-quality, all-in-one kits for winter adventures and family recreation.



Evo™ Ascent Snowshoe Kit

Backcountry-ready kit for winter hikers exploring more rugged, off-trail terrain.

KIT INCLUDES:

- Evo™ Ascent snowshoes, DynaLock™ Explore poles & full-featured carry/storage pack.

PACK SIZE	19L
PACK COLOR	CHARCOAL SNOWSHOE STONE GRAY
SKU	11340
WEIGHT	2714 g (6 lbs)
MADE IN	USA OF U.S. AND IMPORTED MATERIALS



Evo™ Snowshoe Kit

Excellent value for new snowshoers and those discovering their local trails.

KIT INCLUDES:

- Evo™ Trail snowshoes, DynaLock™ Trail poles & full-featured carry/storage pack.

PACK SIZE	19L
PACK COLOR	CHARCOAL SNOWSHOE RED
SKU	10235
WEIGHT	2650 g (5 lb 12 oz)
MADE IN	USA OF U.S. AND IMPORTED MATERIALS

Snowshoe Carry Pack

Full-featured carry-and-storage pack; fits a broad range of snowshoe sizes.

- Widemouth rolltop
- Removable foam seat
- Hydration compatible
- Internal zippered pocket
- Loops for pole attachments

PACK SIZE	19L
COLOR	CHARCOAL
SKU	11363
MADE IN	USA OF U.S. AND IMPORTED MATERIALS



ASCENT SNOWSHOES

Boasting our Paragon Binding for ultimate confidence and foot control, our Ascent Snowshoes remain the pinnacle choice for backcountry travelers in rugged terrain.

Paragon™ Bindings:

Ultra-secure Paragon Bindings offer maximum foot control without pressure points, and pack-flat performance, ideal for mountaineers.

Ultra-durable DTX Crampon:

Hard-wearing design stands up to demanding terrain & use.

Efficient Ergo™ Televator:

Reduces fatigue and increases traction on the steeps.



Lightning™ Ascent

ULTRALIGHT, BEST TRACTION & MAX FOOT SECURITY

MEN'S



WOMEN'S



SIZE	30 IN	25 IN	22 IN
COLOR	COBALT BLUE 13078	13077	13076
	BLACK 13081	13080	13079

MADE IN USA OF U.S. AND IMPORTED MATERIALS

SIZE	25 IN	22 IN
COLOR	RASPBERRY 13083	13082
	GUNMETAL 13085	13084

USA OF U.S. AND IMPORTED MATERIALS

Evo™ Ascent

ULTIMATE DURABILITY



SIZE	22 IN
COLOR	STONE GRAY 05886

MADE IN USA OF U.S. AND IMPORTED MATERIALS

Revo™ Ascent

DURABILITY & MAX FOOT SECURITY

MEN'S



SIZE	25 IN	22 IN
COLOR	OLIVE 13087	13086

USA OF U.S. AND IMPORTED MATERIALS

WOMEN'S



SIZE	25 IN	22 IN
COLOR	DARK CYAN 13089	13088

USA OF U.S. AND IMPORTED MATERIALS

EXPLORE SNOWSHOES

For hiking on and off trail; all-day comfort & ease of use on extended trips.

Easy-to-Use HyperLink™ Binding:

Fast ratchet design, cushioned cradle, all-day comfort.

Efficient Ergo™ Televator:

Reduces fatigue and increases traction on the steeps.

Perimeter Teeth:

Deliver serious traction, especially on traverses.



Lightning™ Explore

ULTRALIGHT & ON-OFF EASE

MEN'S



SIZE	30 IN	25 IN	22 IN
COLOR	INTERNATIONAL ORANGE 10216	10215	10214

MADE IN USA OF U.S. AND IMPORTED MATERIALS

WOMEN'S



SIZE	25 IN	22 IN
COLOR	TEAL 10218	10217

USA OF U.S. AND IMPORTED MATERIALS

Revo™ Explore

ON-OFF EASE & LASTING DURABILITY

MEN'S



SIZE	25 IN	22 IN
COLOR	SPRING GREEN 10222	10221
	CHARTREUSE 10220	10219

MADE IN USA OF U.S. AND IMPORTED MATERIALS

WOMEN'S



SIZE	25 IN	22 IN
COLOR	BRIGHT CORAL 10224	10223
	AQUAMARINE 10226	10225

USA OF U.S. AND IMPORTED MATERIALS

*Kevlar® is a registered trademark of E.I. du Pont de Nemours and Company

TRAIL SNOWSHOES

For minimalists and recreationalists on flat trails or rolling hills.

Pivot™ Crampon & PerimeterTeeth:
Deliver serious traction, especially on traverses.

Lightweight DuoFit™ Binding:
Simple two-strap design is versatile and light.

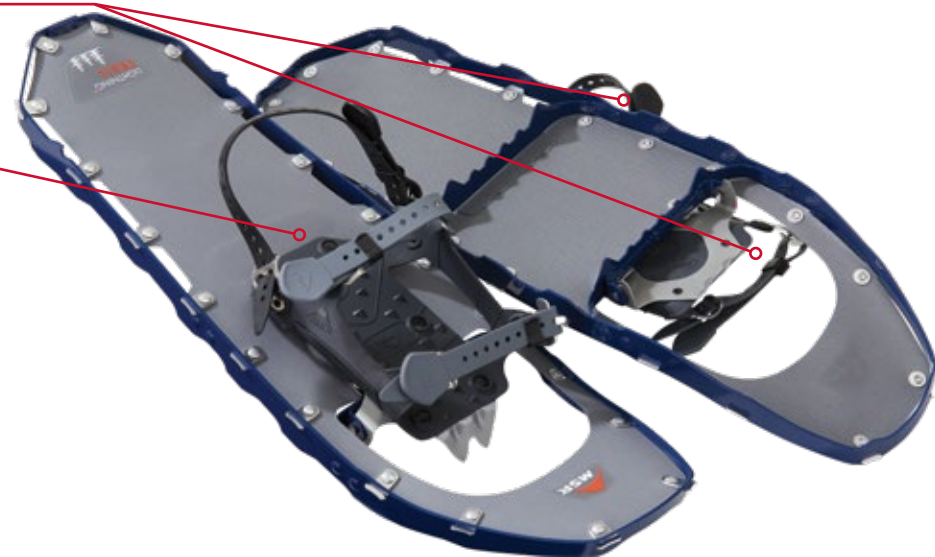

Lightning™ Trail

OUR LIGHTEST SNOWSHOES

MEN'S

WOMEN'S



SIZE	25 IN	22 IN
COLOR	SPECTRUM BLUE 10613	10612
MADE IN	USA OF U.S. AND IMPORTED MATERIALS	

SIZE	25 IN	22 IN
COLOR	CARIBBEAN 10615	10614
MADE IN	USA OF U.S. AND IMPORTED MATERIALS	

Evo™ Trail

DURABLE, GREAT VALUE

UNISEX



SIZE	22 IN		
COLOR	CHARCOAL	DARK TEAL	RED
SKU	10621	10620	05643
MADE IN	USA OF U.S. AND IMPORTED MATERIALS		

Revo™ Trail

STREAMLINED & DURABLE

MEN'S

WOMEN'S



SIZE	25 IN	22 IN
COLOR	MIDNIGHT BLUE 10617	10616
MADE IN	USA OF U.S. AND IMPORTED MATERIALS	

SIZE	25 IN	22 IN
COLOR	BLACK VIOLET 10619	10618
MADE IN	USA OF U.S. AND IMPORTED MATERIALS	

YOUTH SNOWSHOES

Durable and easy-to-use snowshoes designed for growing adventurers.

Shift™

VERSATILE SIZING, WITH GROWN-UP TRACTION

UNISEX



SIZE	19 IN	
COLOR	TRON BLUE	ELECTRIC POP PINK
SKU	10625	10624
MADE IN	USA OF U.S. AND IMPORTED MATERIALS	

Tyker™

EXTRA-STURDY AND DESIGNED FOR KIDS' SMALL STRIDE

UNISEX



SIZE	17 IN	
COLOR	DINO GREEN	PURPLE POWER
SKU	10623	10622
MADE IN	USA OF U.S. AND IMPORTED MATERIALS	

SNOWSHOE ACCESSORIES



Snowshoe Bag

• Fits all 56- and 64-cm (22- and 25-in) MSR snowshoes

SKU	05651
MADE IN	VIETNAM



Snowshoe Maintenance Kit

• Includes: Clevis Pin Assembly, Rivet Field Repair Hardware, Axis™ Hardware, Strap Retainers

SKU	69238
MADE IN	TAIWAN



Paragon Mesh Replacement Straps

• Includes: (2) replacement straps

SKU	13245
MADE IN	USA



Standard Strap Keepers

• Compatible with all current MSR snowshoe bindings

SKU	03652
MADE IN	IRELAND



Paragon/PosiLock™ Replacement Strap

• Includes: (2) replacement straps

14 IN	18 IN
SKU	13308
MADE IN	IRELAND



Classic Snowshoe Strap Kit

• Includes: (2) replacement straps

12 IN	18 IN
SKU	07587
MADE IN	IRELAND



Rental Maintenance Kit

• Includes: (12) 12" Classic Straps, (32) Standard Strap Keepers, (12) Clevis pin assemblies

SKU	03677
MADE IN	IRELAND



HyperLink™ Replacement Straps

• Includes: (2) 6-8" straps, (2) 8-10" straps

SKU	10227
MADE IN	CHINA

SPECIFICATIONS

SNOWSHOES MADE IN USA OF U.S. AND IMPORTED MATERIALS

LIGHTNING™ ASCENT	NAME	COLOR / SKU	SIZE	WEIGHT PER PAIR	TOUR LOAD RANGE	COMPATIBLE TAILS
	LIGHTNING™ ASCENT M 30	13078 13081	76 cm (30 in)	2202 g (4 lb 13 oz)	Up to 136 kg (280 lb)	LIGHTNING
	LIGHTNING™ ASCENT M 25	13077 13080	64 cm (25 in)	1918 g (4 lb 3 oz)	Up to 127 kg (220 lb)	LIGHTNING
	LIGHTNING™ ASCENT M 22	13076 13079	56 cm (22 in)	1844 g (4 lb 1 oz)	Up to 114 kg (180 lb)	LIGHTNING
	LIGHTNING™ ASCENT W 25	13083 13085	64 cm (25 in)	1781 g (3 lb 15oz)	Up to 127 kg (220 lb)	LIGHTNING
	LIGHTNING™ ASCENT W 22	13082 13084	56 cm (22 in)	1710 g (3 lb 12 oz)	Up to 114 kg (180 lb)	LIGHTNING

REVO™ ASCENT	NAME	COLOR / SKU	SIZE	WEIGHT PER PAIR	TOUR LOAD RANGE	COMPATIBLE TAILS
	REVO™ ASCENT M 25	13087	64 cm (25 in)	2138 g (4 lb 11 oz)	Up to 127 kg (220 lb)	REVO
	REVO™ ASCENT M 22	13086	56 cm (22 in)	1952 g (4 lb 5 oz)	Up to 114 kg (180 lb)	REVO
	REVO™ ASCENT W 25	13089	64 cm (25 in)	2016 g (4 lb 7 oz)	Up to 127 kg (220 lb)	REVO
	REVO™ ASCENT W 22	13088	56 cm (22 in)	1839 g (4 lb 1 oz)	Up to 114 kg (180 lb)	REVO

LIGHTNING™ EXPLORE	NAME	COLOR / SKU	SIZE	WEIGHT PER PAIR	TOUR LOAD RANGE	COMPATIBLE TAILS
	LIGHTNING™ EXPLORE M 30	10216	76 cm (30 in)	2040 g (4 lb 8 oz)	Up to 136 kg (280 lb)	LIGHTNING
	LIGHTNING™ EXPLORE M 25	10215	64 cm (25 in)	1768 g (3 lb 14 oz)	Up to 127 kg (220 lb)	LIGHTNING
	LIGHTNING™ EXPLORE M 22	10214	56 cm (22 in)	1696 g (3 lb 12 oz)	Up to 114 kg (180 lb)	LIGHTNING
	LIGHTNING™ EXPLORE W 25	10218	64 cm (25 in)	1660 g (3 lb 11 oz)	Up to 127 kg (220 lb)	LIGHTNING
	LIGHTNING™ EXPLORE W 22	10217	56 cm (22 in)	1589 g (3 lb 8 oz)	Up to 114 kg (180 lb)	LIGHTNING

REVO™ EXPLORE	NAME	COLOR / SKU	SIZE	WEIGHT PER PAIR	TOUR LOAD RANGE	COMPATIBLE TAILS
	REVO™ EXPLORE M 25	10222 10220	64 cm (25 in)	1920 g (4 lb 4 oz)	Up to 127 kg (220 lb)	REVO
	REVO™ EXPLORE M 22	10221 10219	56 cm (22 in)	1803 g (4 lb)	Up to 114 kg (180 lb)	REVO
	REVO™ EXPLORE W 25	10224 10226	64 cm (25 in)	1862 g (4 lb 2 oz)	Up to 127 kg (220 lb)	REVO
	REVO™ EXPLORE W 22	10223 10225	56 cm (22 in)	1711 g (3 lb 12 oz)	Up to 114 kg (180 lb)	REVO

LIGHTNING™ TRAIL	NAME	COLOR / SKU	SIZE	WEIGHT PER PAIR	TOUR LOAD RANGE	COMPATIBLE TAILS
	LIGHTNING™ TRAIL M 25	10613	64 cm (25 in)	1520 g (3 lb 6 oz)	Up to 127 kg (220 lb)	LIGHTNING
	LIGHTNING™ TRAIL M 22	10612	56 cm (22 in)	1450 g (3 lb 3 oz)	Up to 114 kg (180 lb)	LIGHTNING
	LIGHTNING™ TRAIL W 25	10615	64 cm (25 in)	1400 g (3 lb 1 oz)	Up to 127 kg (220 lb)	LIGHTNING
	LIGHTNING™ TRAIL W 22	10614	56 cm (22 in)	1330 g (2 lb 15 oz)	Up to 114 kg (180 lb)	LIGHTNING

REVO™ TRAIL	NAME	COLOR / SKU	SIZE	WEIGHT PER PAIR	TOUR LOAD RANGE	COMPATIBLE TAILS
	REVO™ TRAIL M 25	10617	64 cm (25 in)	1755 g (3 lb 14 oz)	Up to 127 kg (220 lb)	REVO
	REVO™ TRAIL M 22	10616	56 cm (22 in)	1625 g (3 lb 9 oz)	Up to 114 kg (180 lb)	REVO
	REVO™ TRAIL W 25	10619	64 cm (25 in)	1705 g (3 lb 12 oz)	Up to 127 kg (220 lb)	REVO
	REVO™ TRAIL W 22	10618	56 cm (22 in)	1550 g (3 lb 7 oz)	Up to 114 kg (180 lb)	REVO

CLASSIC SERIES	NAME	COLOR / SKU	SIZE	WEIGHT PER PAIR	TOUR LOAD RANGE	COMPATIBLE TAILS
	EVO™ ASCENT	05886	56 cm (22 in)	1843 g (4 lb 1 oz)	Up to 114 kg (180 lb)	EVO
	EVO™ TRAIL	10621 10620 05643	56 cm (22 in)	1620 g (3 lb 9 oz)	Up to 114 kg (180 lb)	EVO
	SHIFT™	10625 10624	49.5 cm (19 in)	1145 g (2 lb 8 oz)	Up to 57 kg (125 lb)	
	TYKER™	10623 10622	43 cm (17 in)	930 g (2 lb 1 oz)	Up to 36 kg (80 lb)	

RENTALS	NAME	COLOR / SKU	SIZE	WEIGHT PER PAIR	TOUR LOAD RANGE	COMPATIBLE TAILS
	EVO™ ASCENT	06031	56 cm (22 in)	1843 g (4 lb 1 oz)	Up to 114 kg (180 lb)	EVO
	EVO™ TRAIL	06032	56 cm (22 in)	1620 g (3 lb 9 oz)	Up to 114 kg (180 lb)	EVO
	SHIFT™	10818	49.5 cm (19 in)	1145 g (2 lb 8 oz)	Up to 57 kg (125 lb)	
	TYKER™	10819	43 cm (17 in)	930 g (2 lb)	Up to 36 kg (80 lb)	
	EVO™ TAIL	06036	15.2 cm (6 in)	340 g (12 oz)		

TAILS	NAME	COLOR / SKU	SIZE	WEIGHT PER PAIR
	LIGHTNING™ TAIL	05648	12.7 cm (5 in)	255 g (9 oz)
	REVO™ TAIL	05649	12.7 cm (5 in)	298 g (10.5 oz)
	EVO™ TAIL	05650	15.2 cm (6 in)	340 g (12 oz)

POLES	NAME	SKU	PACKED LENGTH	ADJUSTABLE LENGTH	WEIGHT PER PAIR
	DYNALOCK™ ASCENT CARBON SM	10236	36 cm (14 in)	100-120 cm	471 g (1 lb 1 oz)
	DYNALOCK™ ASCENT CARBON LG	10237	44 cm (17.5 in)	120-140 cm	496 g (1 lb 2 oz)
	DYNALOCK™ EXPLORE	10238	62 cm (24 in)	63-140 cm	552 g (1 lb 3 oz)
	DYNALOCK™ TRAIL	10239	80 cm (31 in)	81-140 cm	592 g (1 lb 5 oz)

SNOWSHOE KITS MADE IN USA OF U.S. AND IMPORTED MATERIALS

NAME	SKU	PACKED LENGTH	ADJUSTABLE LENGTH	KIT WEIGHT	PACK CAPACITY
EVO™ SNOWSHOE KIT	10235	80 cm (31 in)	81-140 CM	2650 g (5 lb 12 oz)	19 L
EVO™ ASCENT SNOWSHOE KIT	11340	62 cm (24 in)	63-140 CM	2714 g (6 lbs)	19 L



SNOW SHOVELS

Unrelenting strength. Optimized ergonomics.

Fast-Deploy Shaft:
Unique tri-lobe shape prevents rotation.

High-Strength Blade:
6061-T6 aluminum and neckless design add durability & ultra-packability.

Serrated Edge:
Concentration points break up snow and ice.



Operator™ T Shovel



Operator™ D Shovel
Basecamp & Backcountry Shovel

SKU	03159
LENGTH	84 cm (33 in)
PACKED SIZE	62 cm (25 in)
WEIGHT	656 g (1 lb 7 oz)
MADE IN	TAIWAN



Responder™ Shovel
Basecamp & Backcountry Shovel

SKU	03157
LENGTH	88 cm (35 in)
PACKED SIZE	66 cm (26 in)
WEIGHT	665 g (1 lb 8 oz)
MADE IN	TAIWAN



Operator™ T Shovel
Snow Science & Rescue Shovel

SKU	03158
LENGTH	81 cm (32 in)
PACKED SIZE	59 cm (23 in)
WEIGHT	590 g (1 lb 5 oz)
MADE IN	TAIWAN



AVALANCHE PROBES

Maximum stiffness. Minimum weight.

Dual-Diameter Construction:

Burlier lowers reduce deflection; traditional uppers shed weight.

Tapered, Quick-Link Ferrules:

For fast assembly.

T-Handle:

Easy to grab for max efficiency when seconds count.



Striker™ 320



Striker™ CX 320 Probe

Carbon Fiber & 7000 Series Aluminum Probe

SKU	03156
LENGTH	320 cm (126 in)
PACKED SIZE	46 cm (18 in)
WEIGHT	296 g (10.5 oz)
MADE IN	KOREA

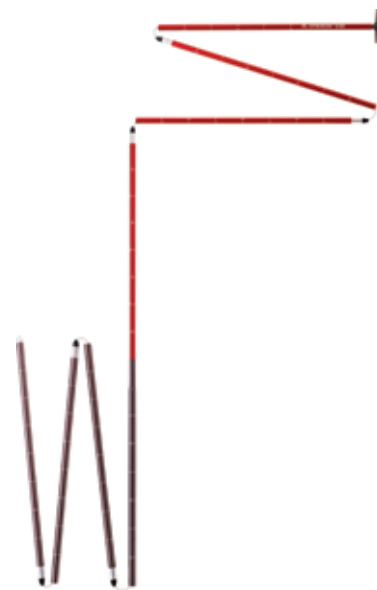

Striker™ 320 Probe

7000 Series Aluminum Probe

SKU	03160
LENGTH	320 cm (126 in)
PACKED SIZE	46 cm (18 in)
WEIGHT	355 g (13 oz)
MADE IN	KOREA



Striker™ 240 Probe

7000 Series Aluminum Touring Probe

SKU	03161
LENGTH	240 cm (94 in)
PACKED SIZE	46 cm (18 in)
WEIGHT	290g(10oz)
MADE IN	KOREA

ANCHORS

Legendary reliability when it matters most.

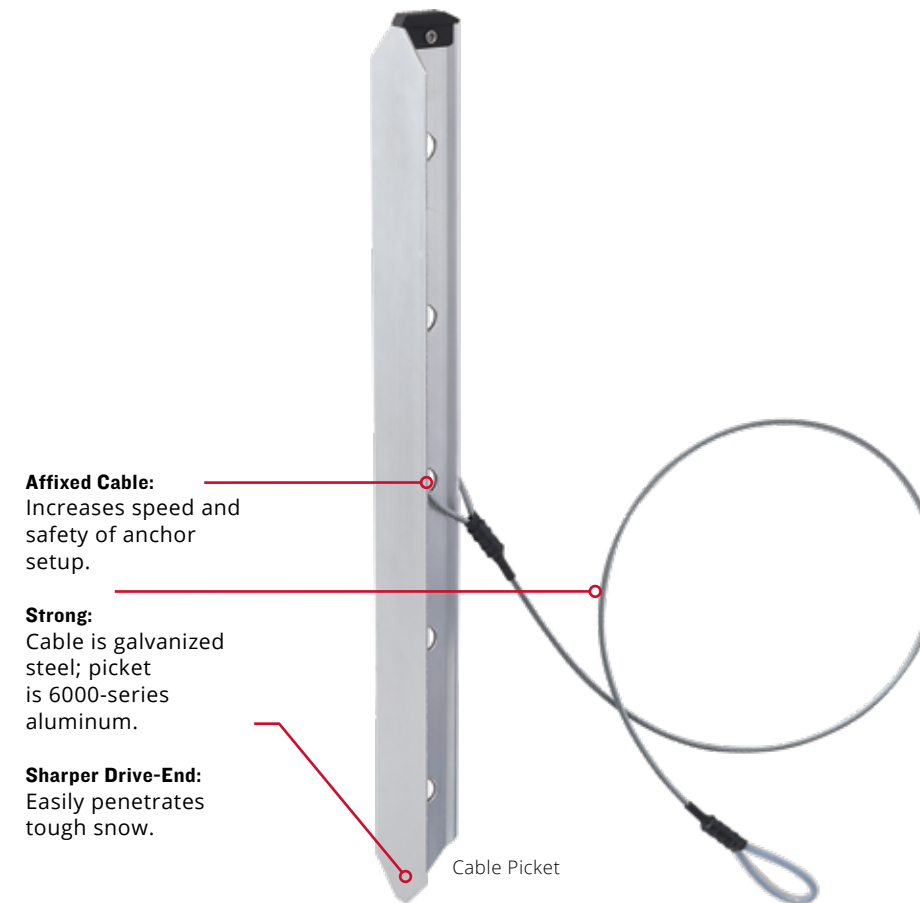

Affixed Cable:

Increases speed and safety of anchor setup.

Strong:

Cable is galvanized steel; picket is 6000-series aluminum.

Sharper Drive-End:

Easily penetrates tough snow.

Cable Picket



Snow Fluke

	Small	Large
SKU	06863	06864
WEIGHT	196 g (6.9 oz)	249 g (8.8 oz)
MADE IN	USA OF U.S. AND IMPORTED MATERIALS	



Snow Pickets

	53 cm	90 cm
SKU	10949	10950
WEIGHT	454 g (16 oz)	611 g (21.5 oz)
CABLE LENGTH	104 cm (41 in)	
CABLE DIAMETER	4 mm (5/32 in)	
MADE IN	USA	

SNOW SAWS

Elite performance in the field.



Basecamp™ Snow Shelter Saw

SKU	03153
LENGTH	75 cm (30 in)
PACKED SIZE	45 cm (17.5 in)
WEIGHT	364 g (13 oz)
MADE IN	USA OF U.S. AND IMPORTED MATERIALS



Beta™ Snow Science Saw

SKU	03155
LENGTH	47 cm (18.5 in)
PACKED SIZE	N/A
WEIGHT	180 g (7 oz)
MADE IN	USA OF U.S. AND IMPORTED MATERIALS